

# Component Guide

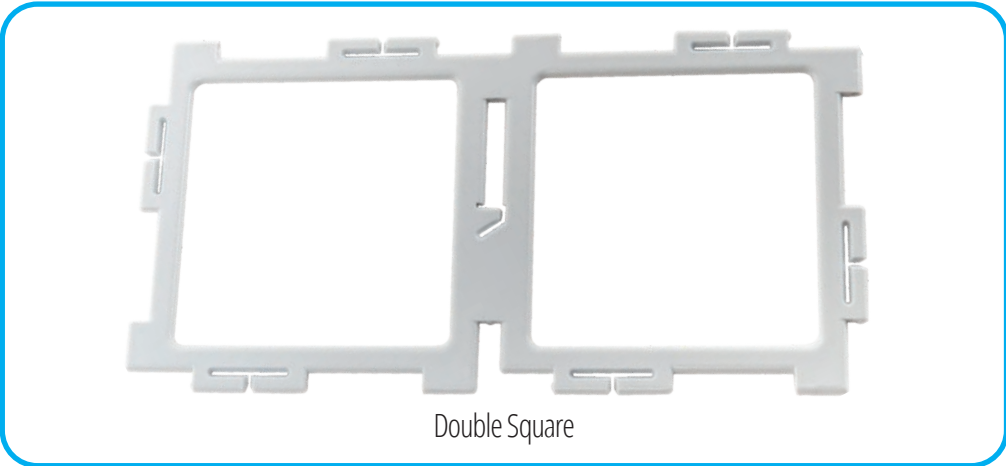

# Cable Car

1

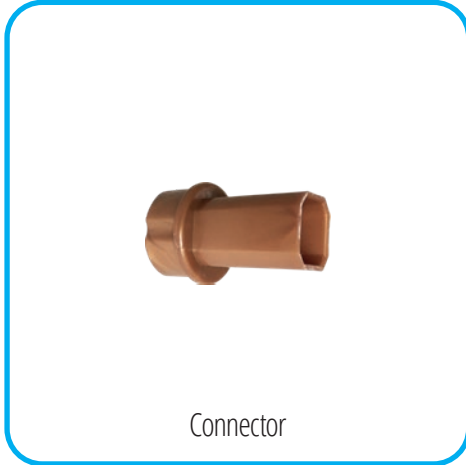
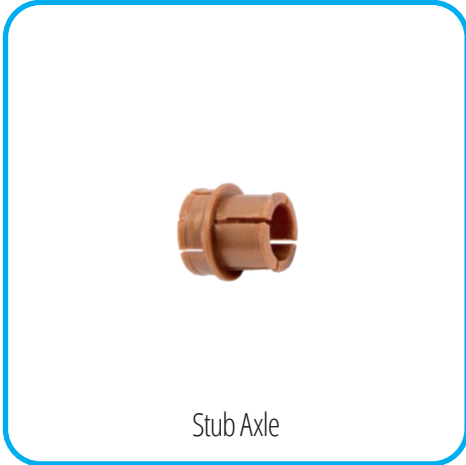
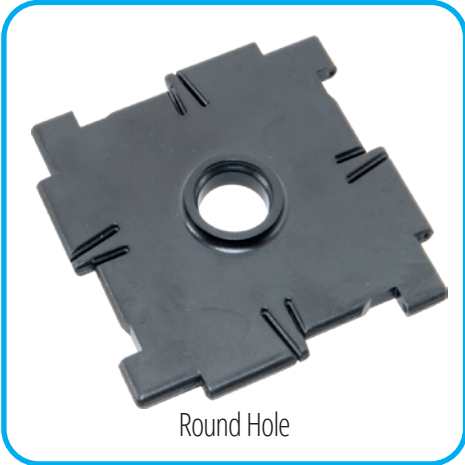
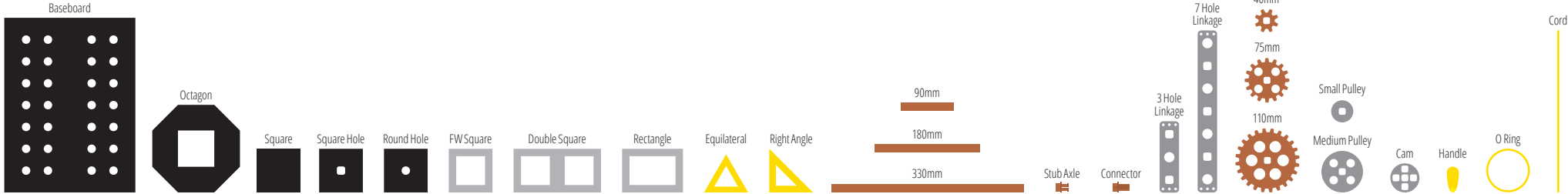

1



4



5

2

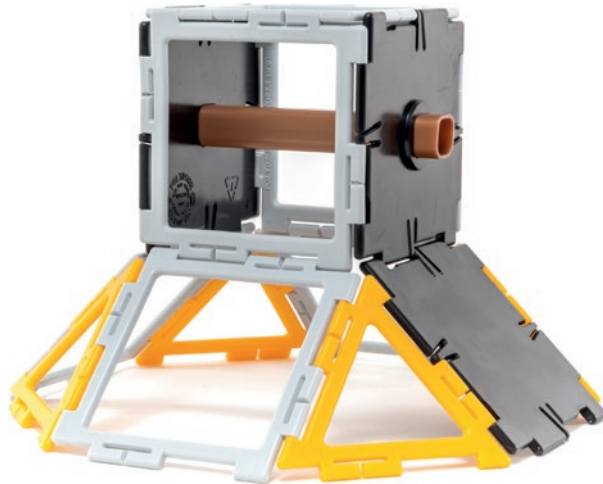

4



6



1

Square Hole



2

90mm

1

3



2

Medium Pulley



2

Connector



1

Stub Axle

2

1 + 2 + 3

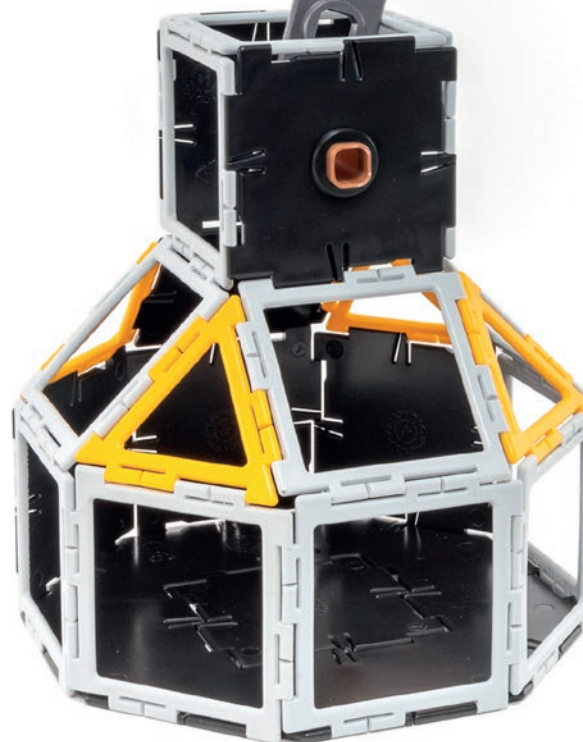
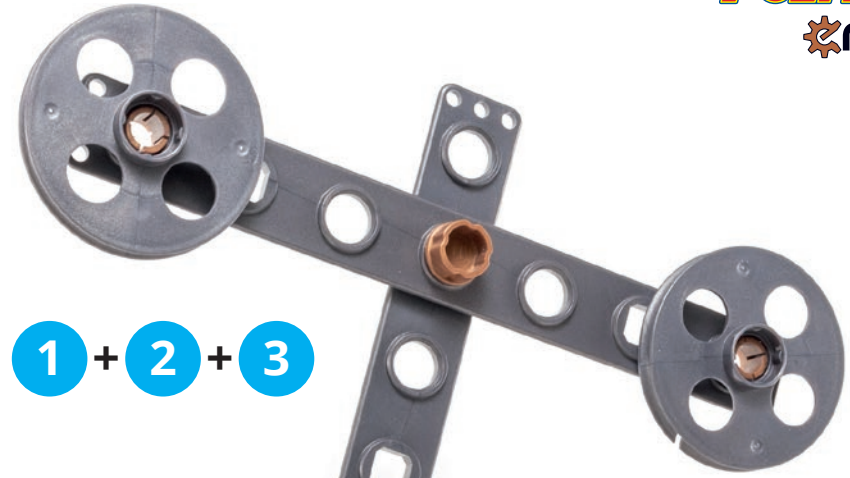



# Big Gear Toy 1

1

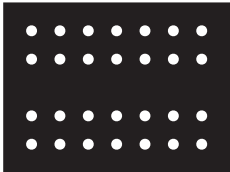
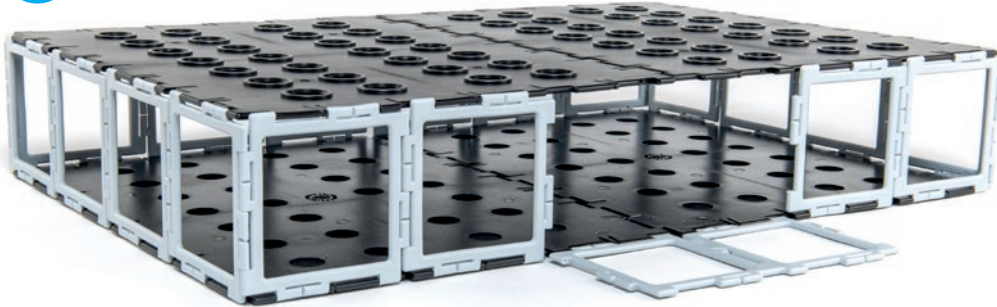

4

Double Square



2



16

2

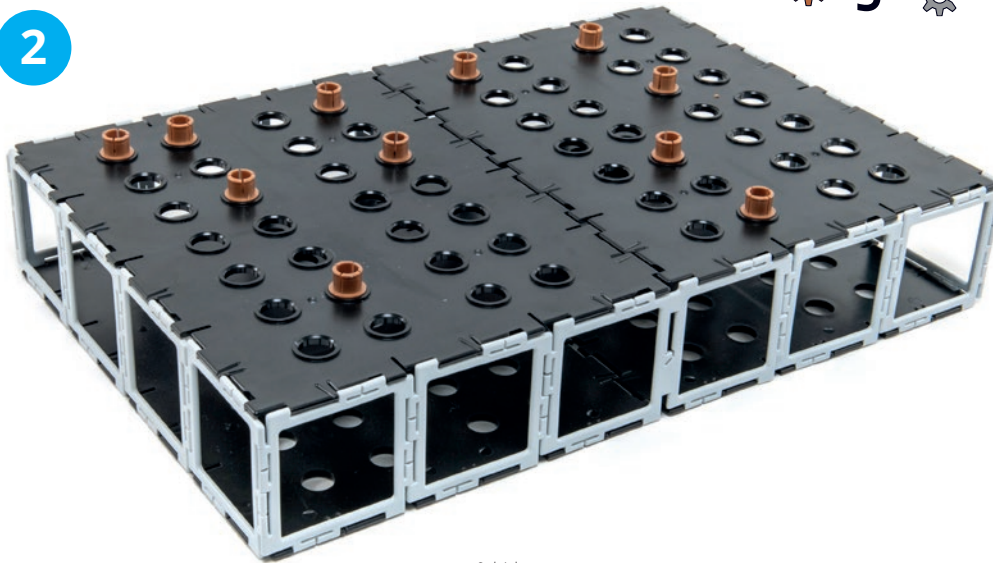

Stub Axle

11

3

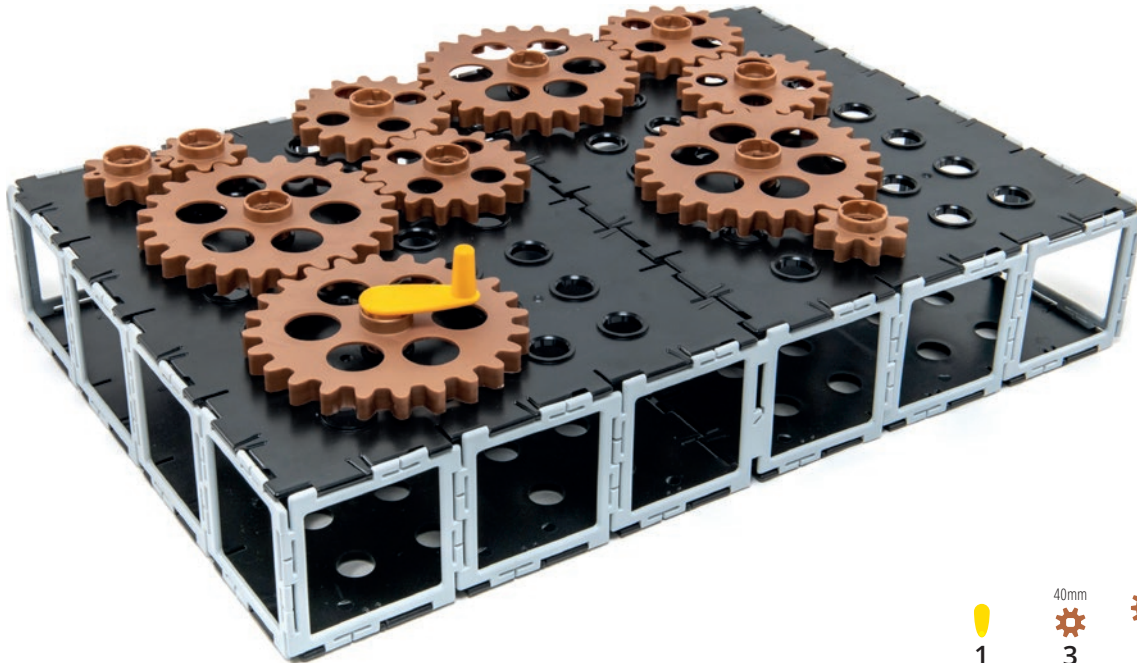

1



3



4



4

# Big Gear Toy 2

1

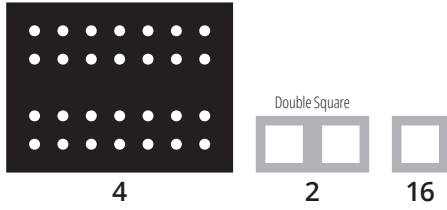
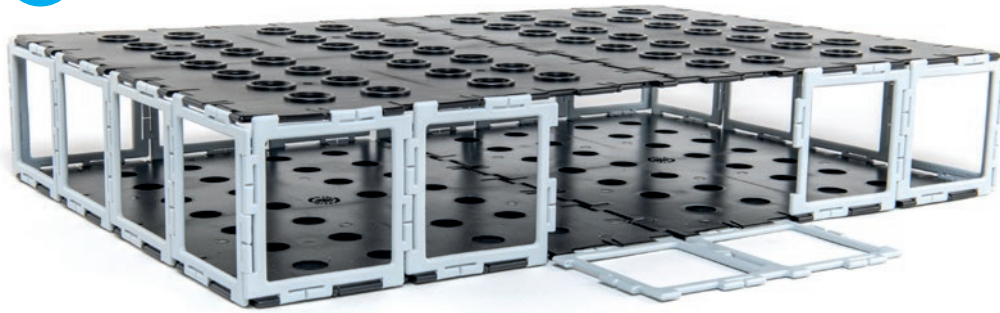

2

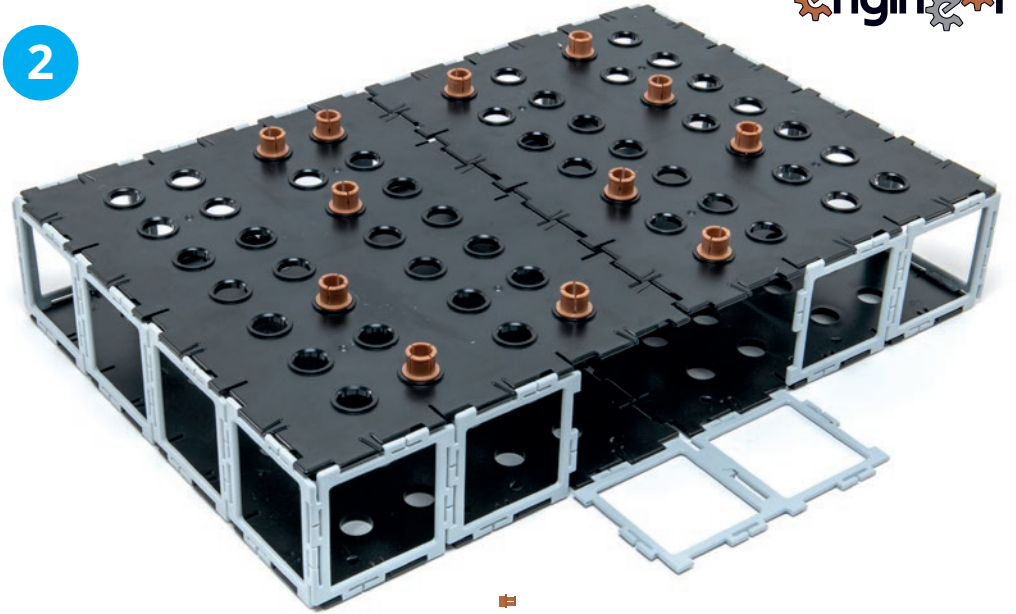

12

3



4

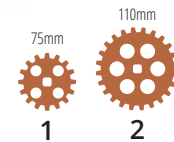



# Four Cylinder Engine

1

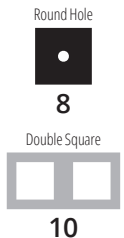
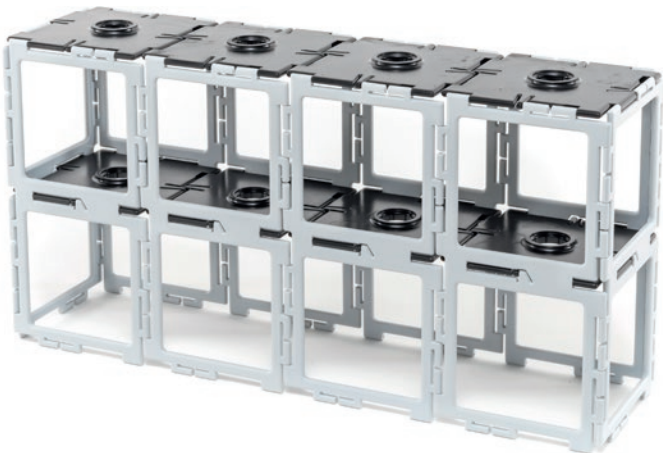

2



3

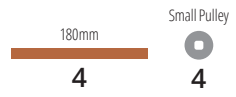

4

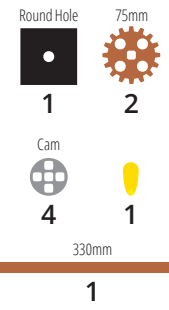

2  
+  
3  
+  
4

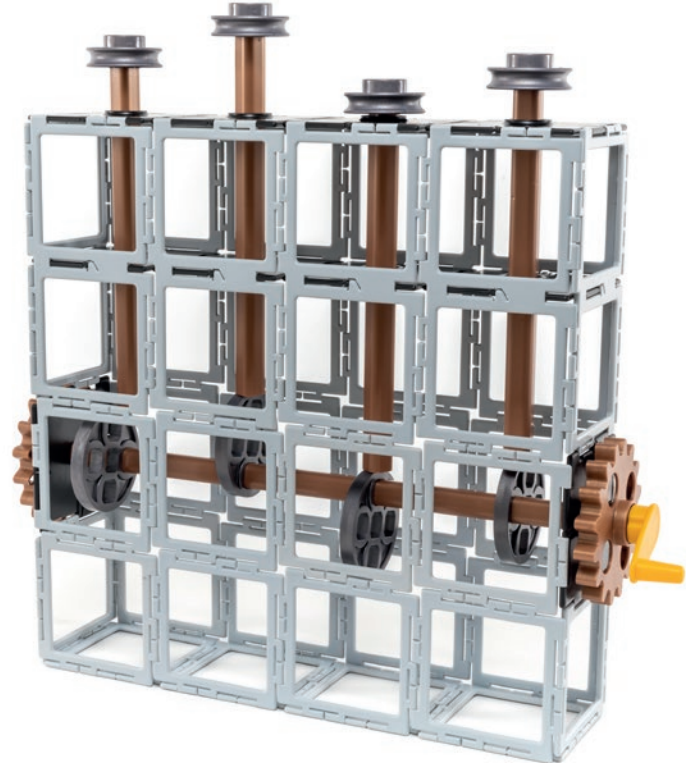

# Gearbox

1

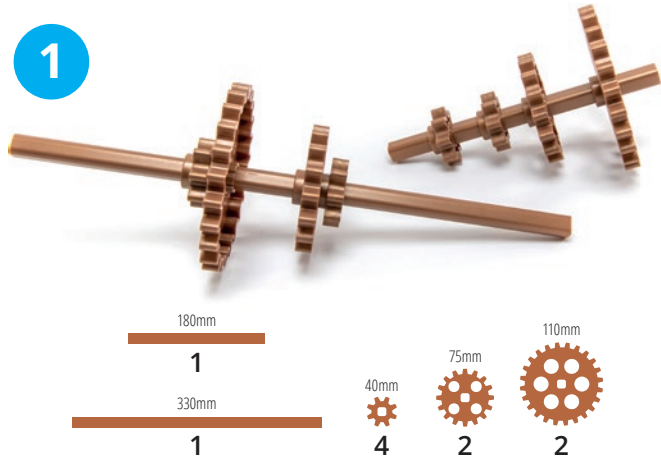

2

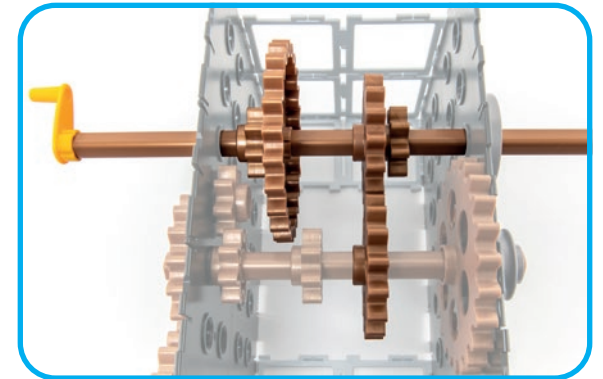
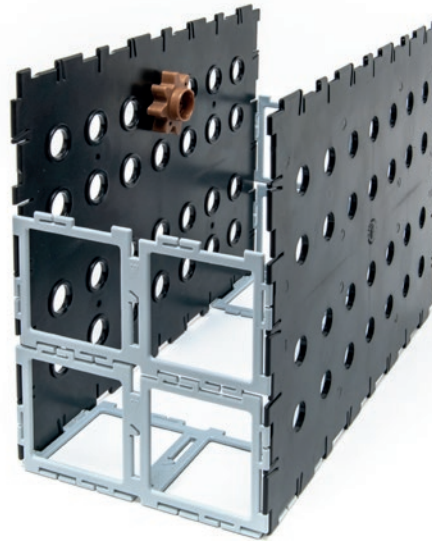
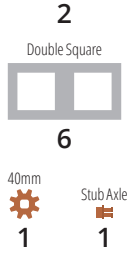
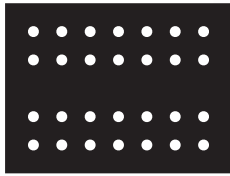

3

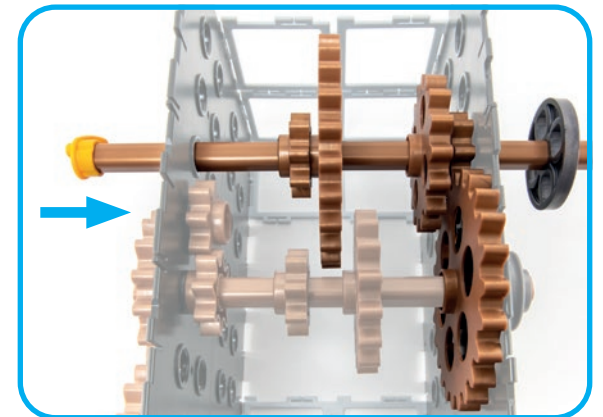
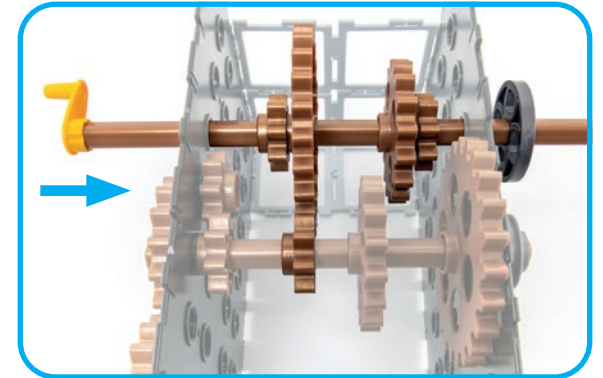
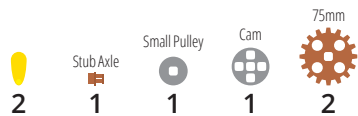
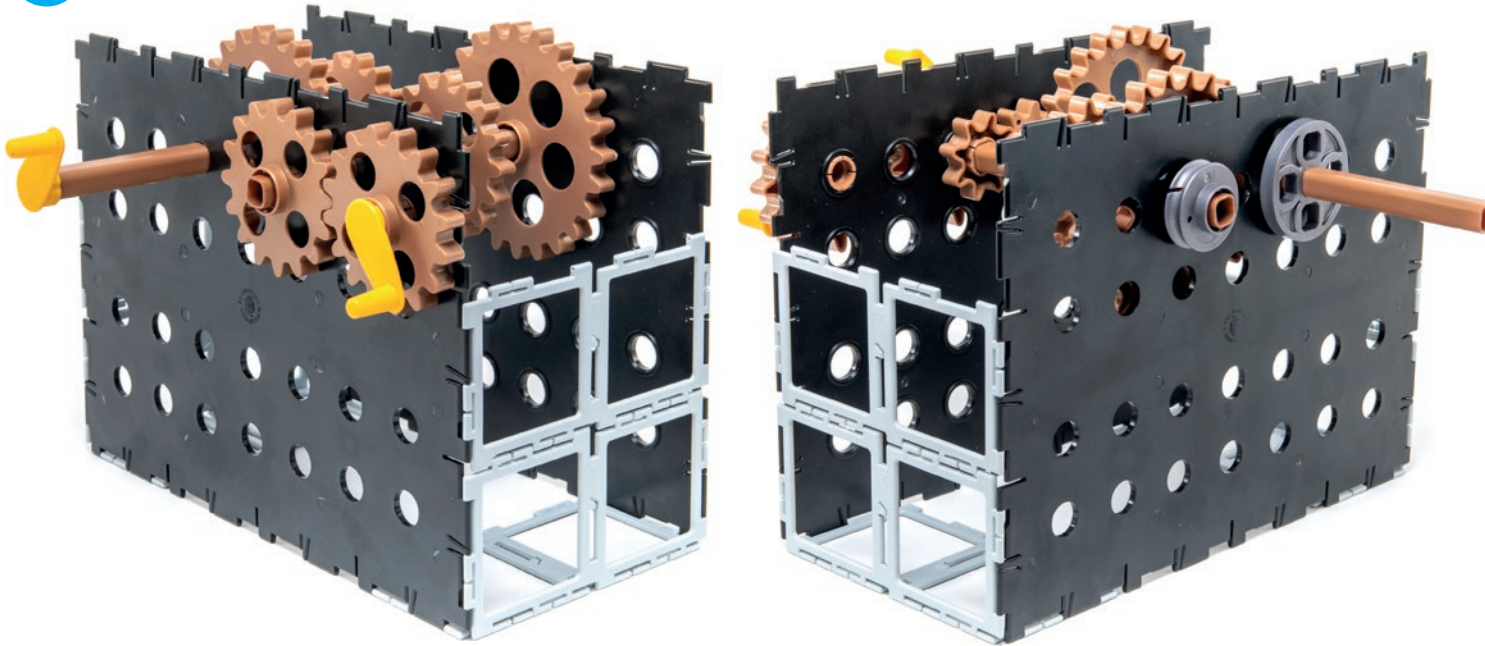



# Gear Toy 1

1

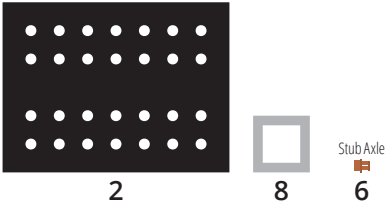
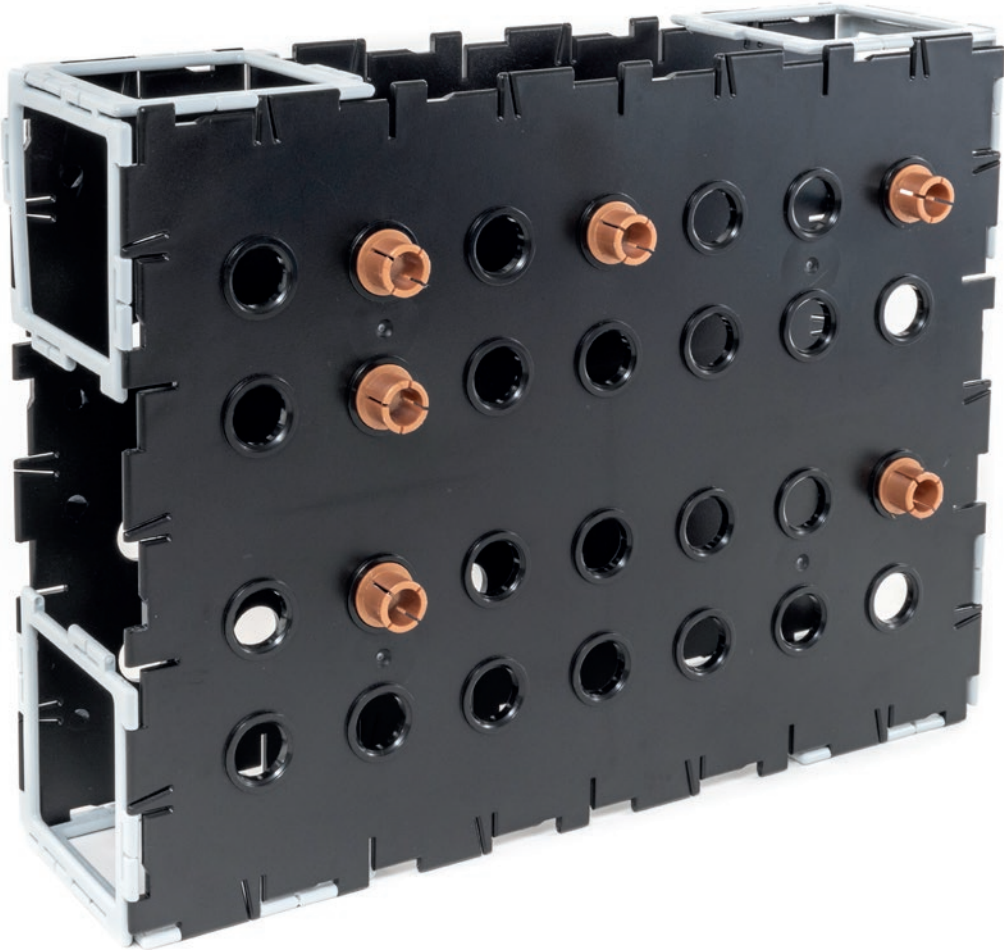

2

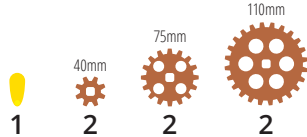
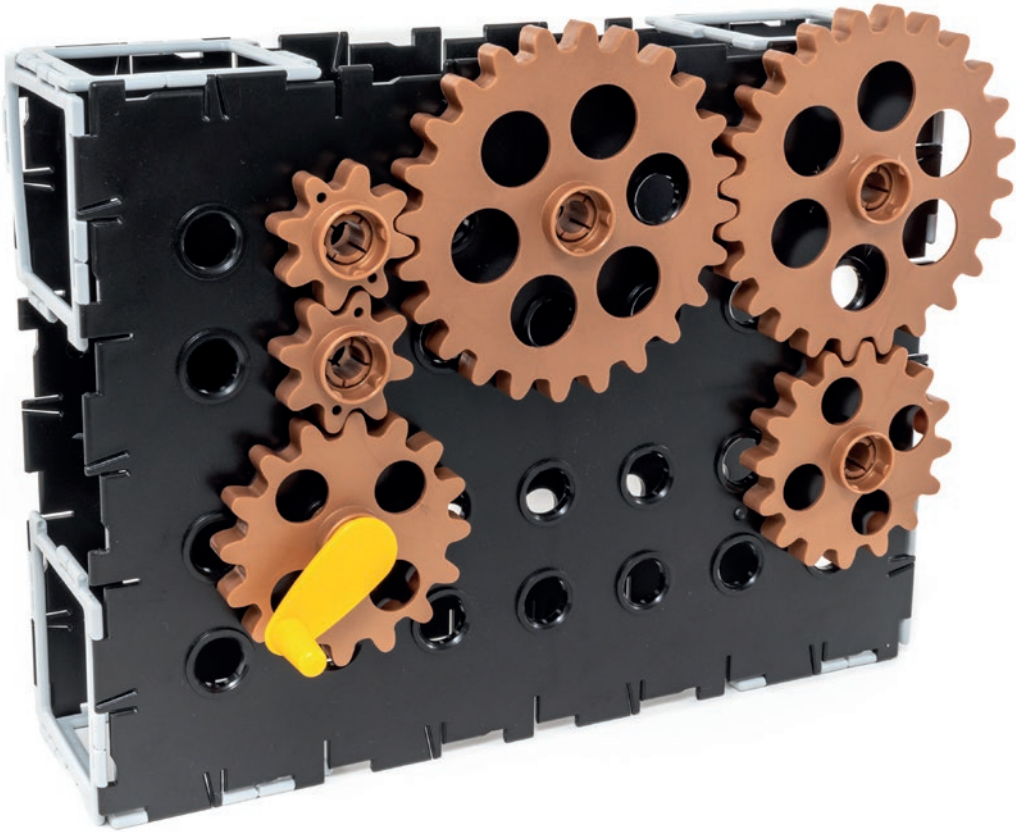

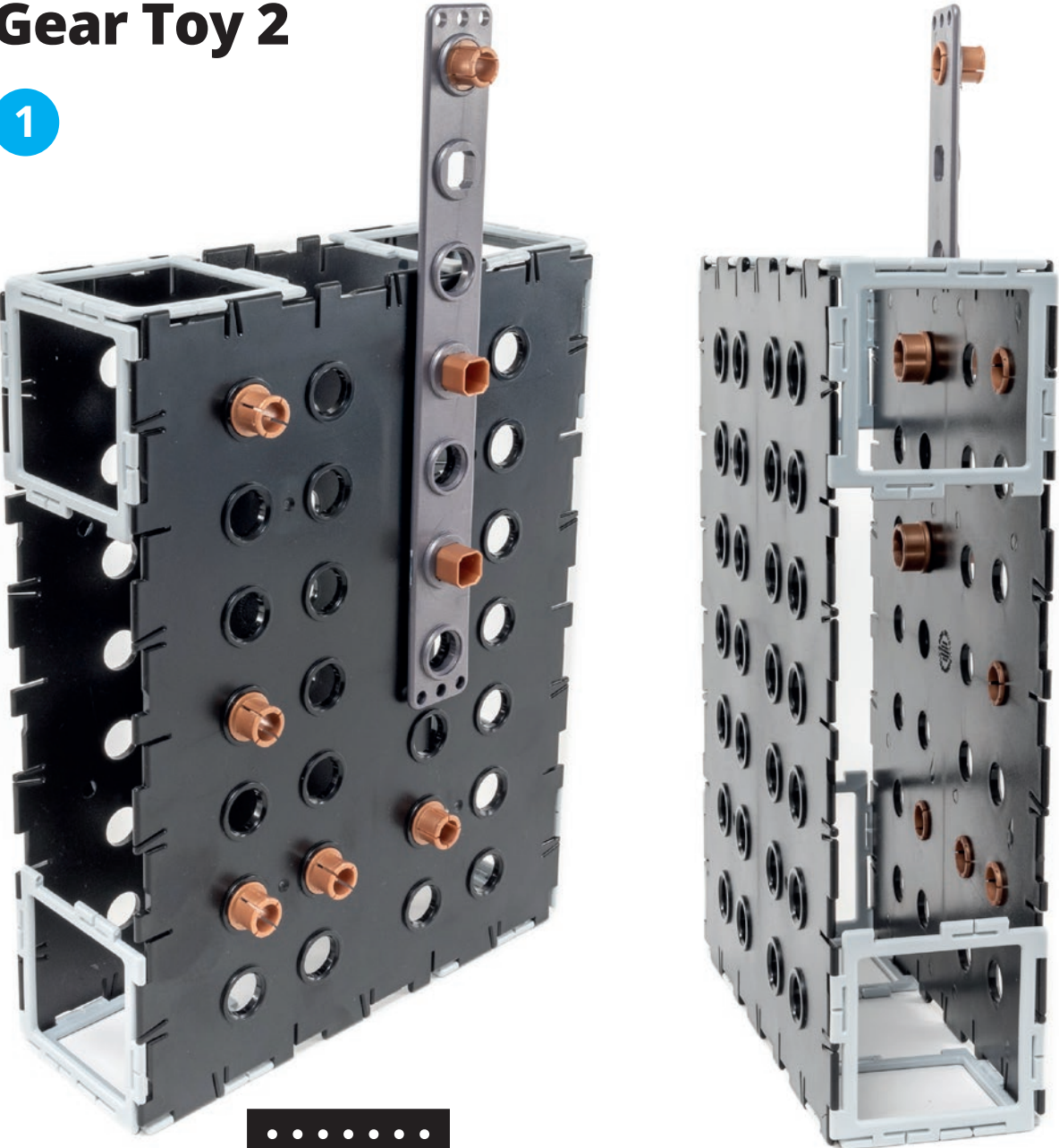

# Gear Toy 2

1

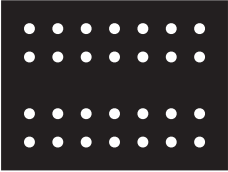

- 

2
- 

8
- 

Stub Axle  
6
- 

Connector  
2
- 

1

2





- 

1
- 

1
- 

Small Pulley  
1
- 

Medium Pulley  
1
- 

40mm  
2
- 

75mm  
1
- 

110mm  
2

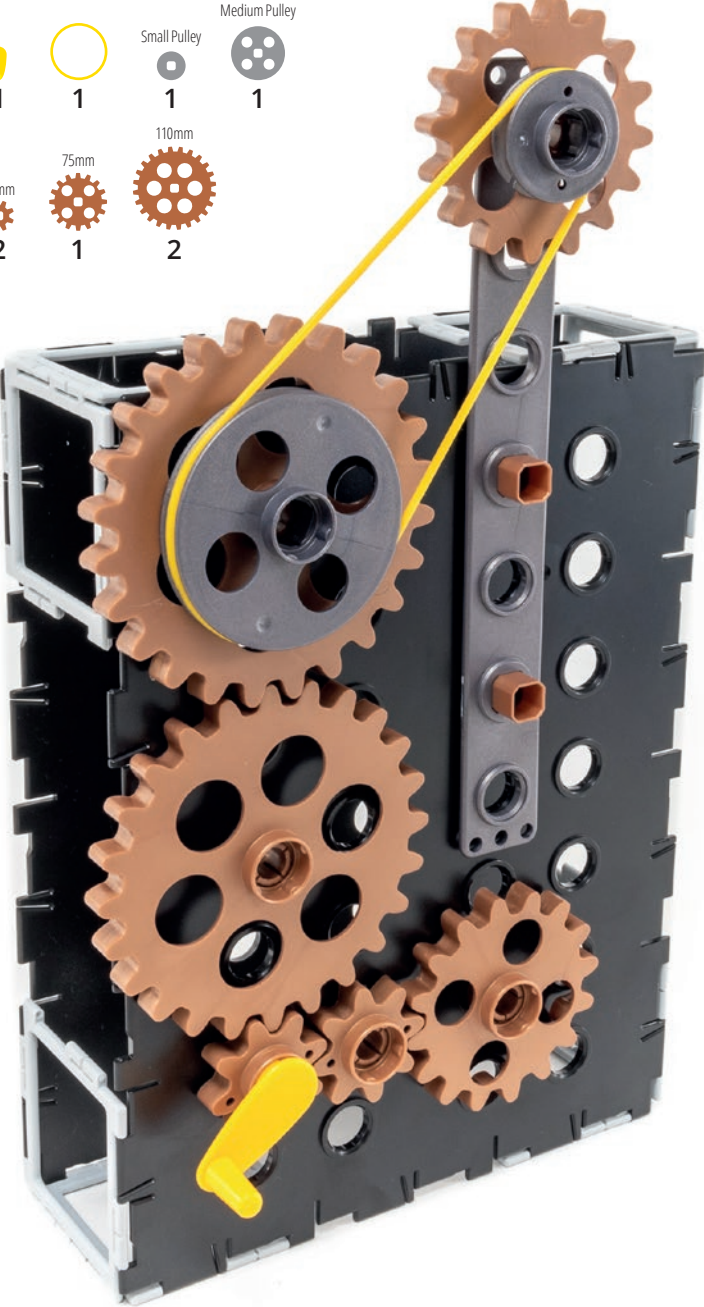



# Chairspinner

1

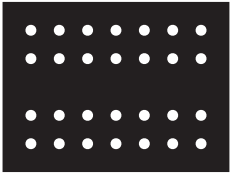
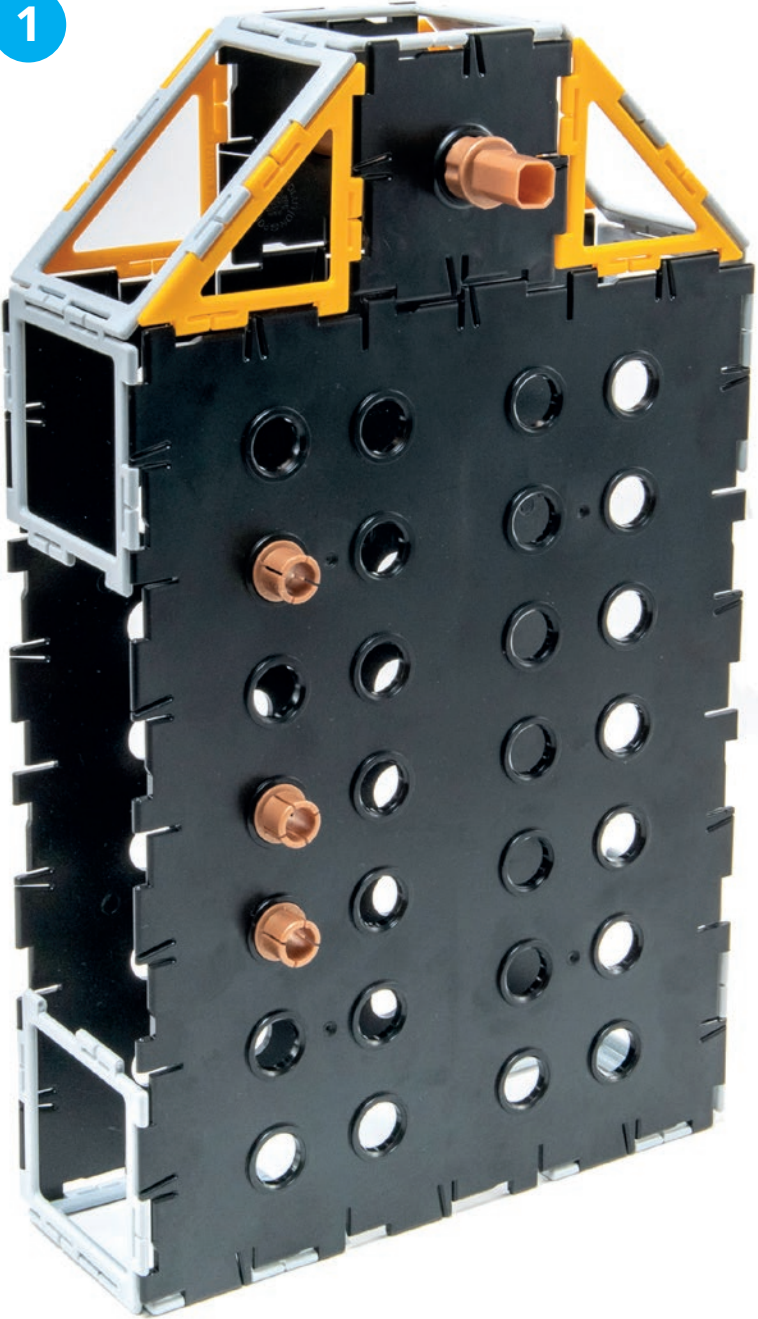

2

Round Hole



2



7



4



2

Connector



2

90mm



1

Stub Axle



3

2



1



1

Medium Pulley



2

40mm



2

110mm



1



3



-  2
-  2
-  2
-  4
-  3
-  4



2 + 3

**POLYDRON**  
 Engin<sup>er</sup>

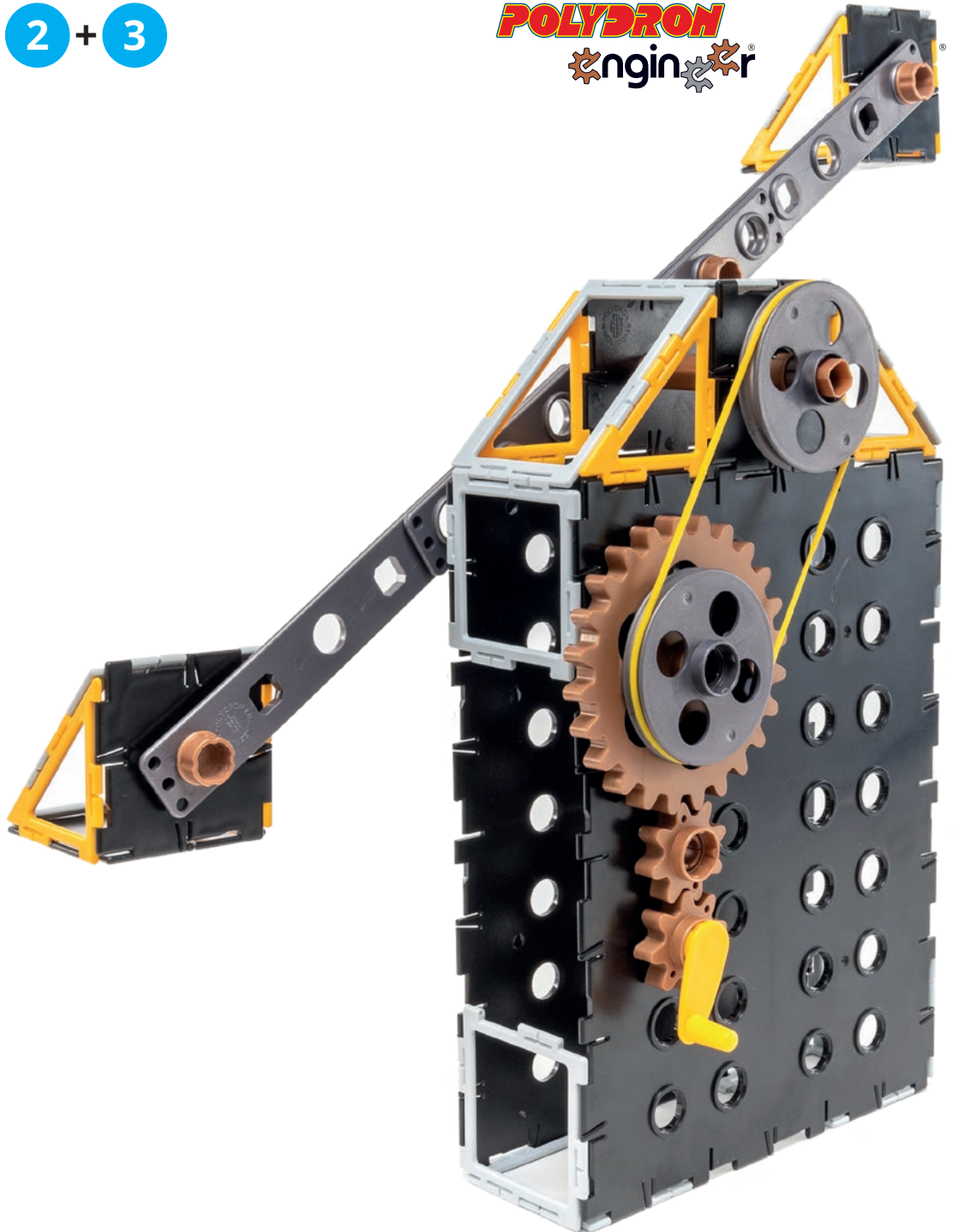







# Crane

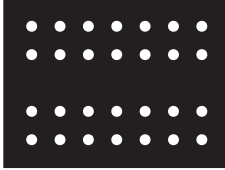





1

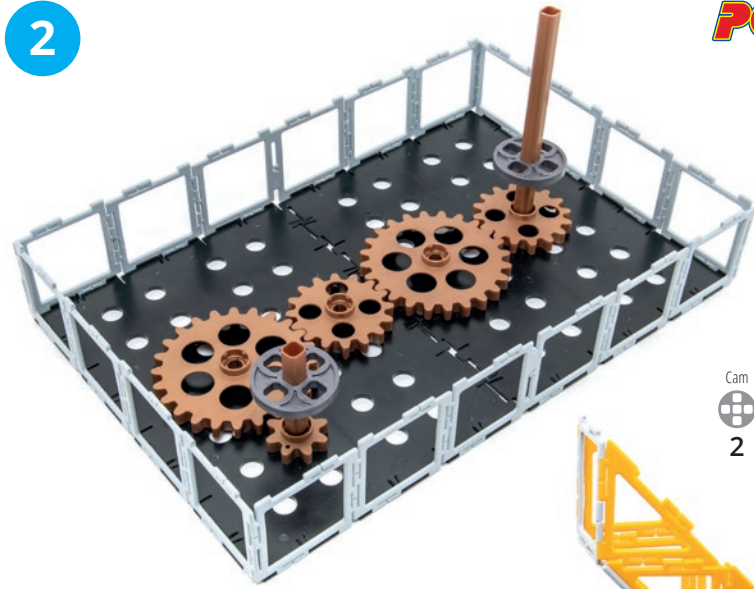

-  2
- Double Square  
 2
-  16
- Stub Axle  
 3



2

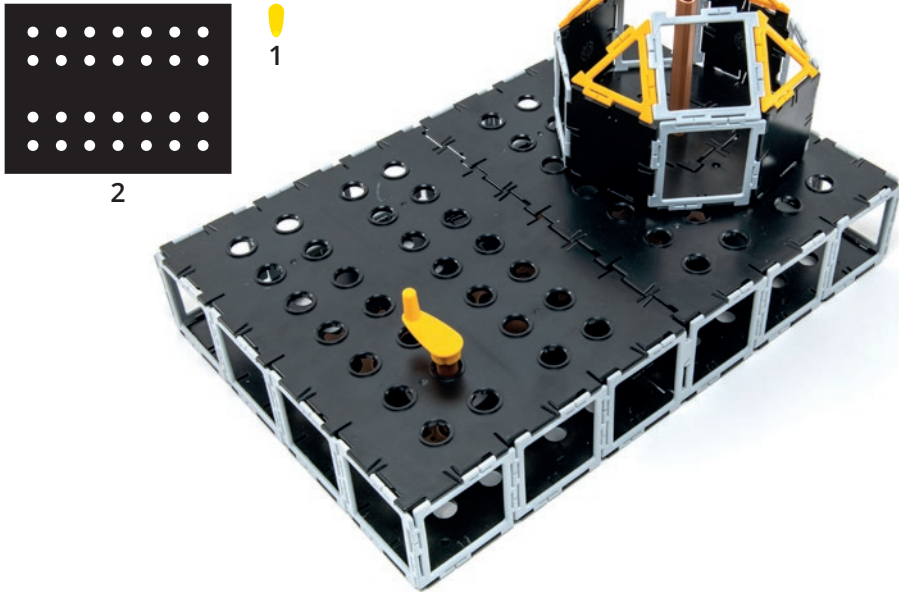

- 90mm  
 1
- 180mm  
 1
- 110mm  
 2
- 75mm  
 2
- 40mm  
 1
- Cam  
 2

3



-  2
-  1

-  1
- Square Hole  
 1
-  4
-  6
-  4



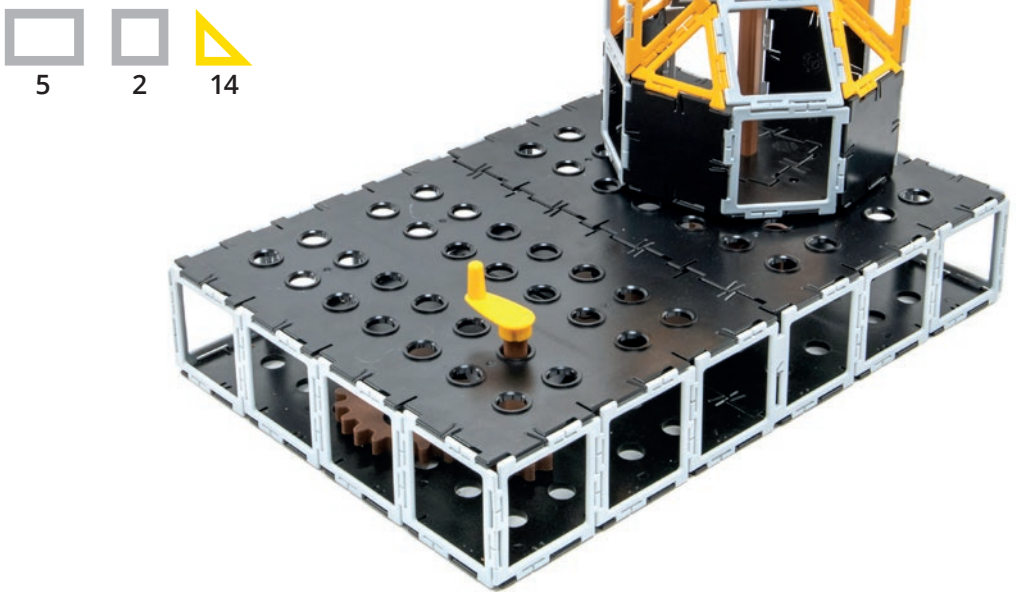

4



-  5
-  2
-  14

5







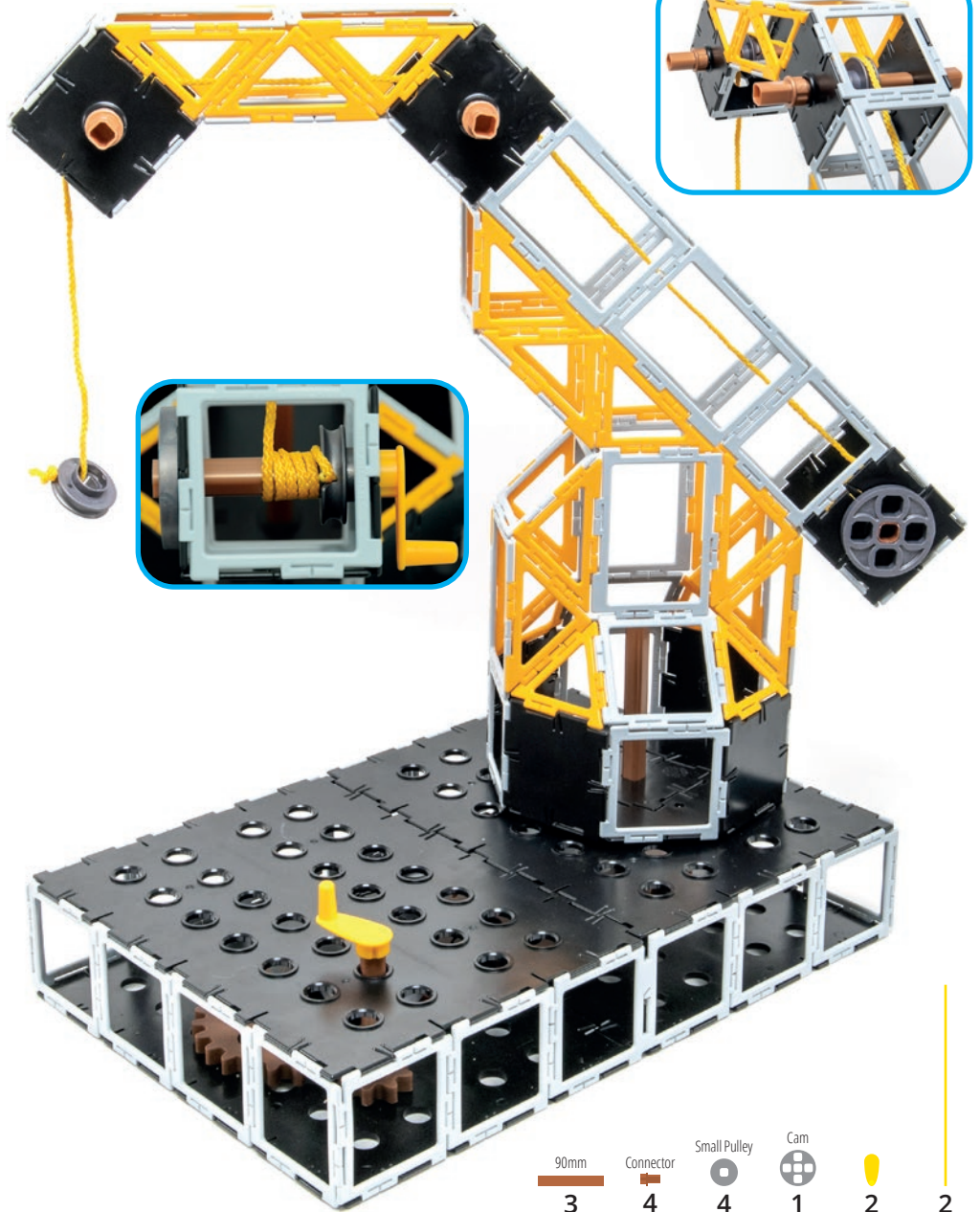

-  10
-  9
-  Round Hole 7
-  6

6



**POLYDRON**  
 Engin<sup>®</sup>

-  90mm 3
-  Connector 4
-  Small Pulley 4
-  Cam 1
-  2
-  2



# Gyro

1

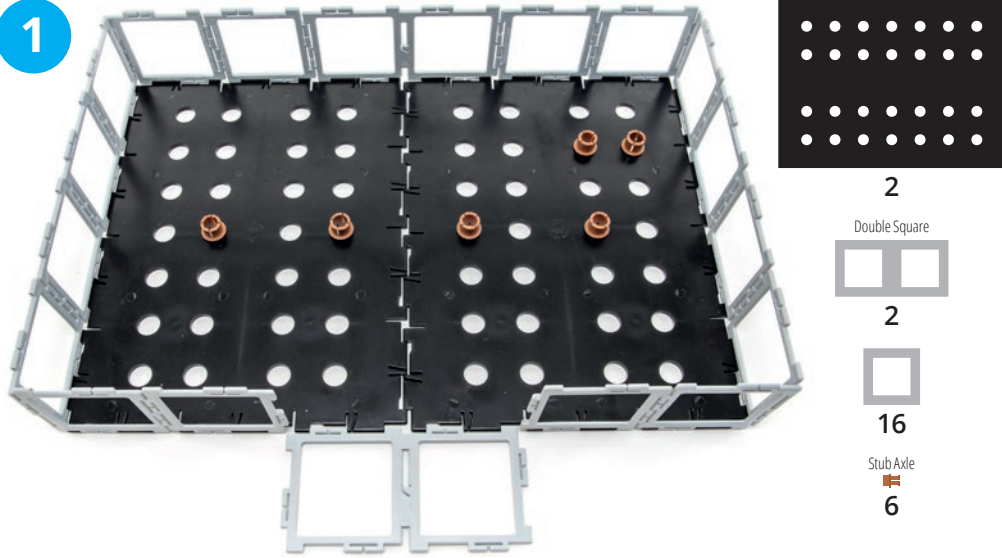

2

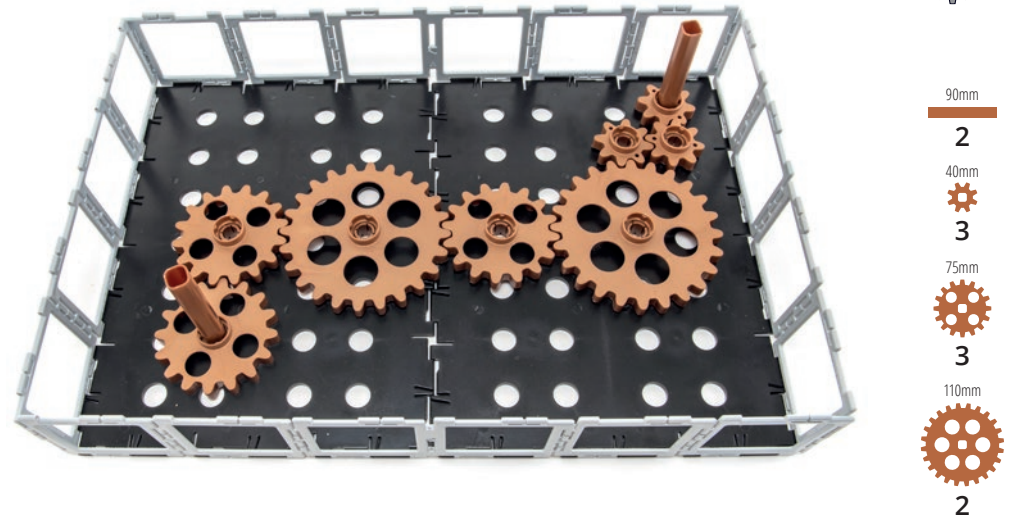

3

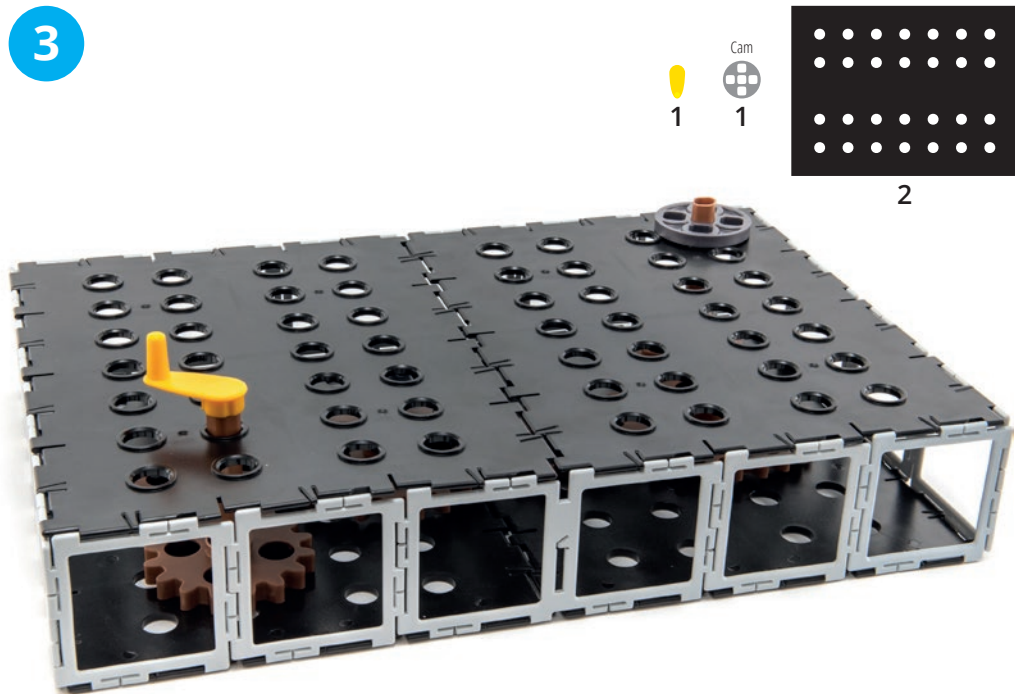

4

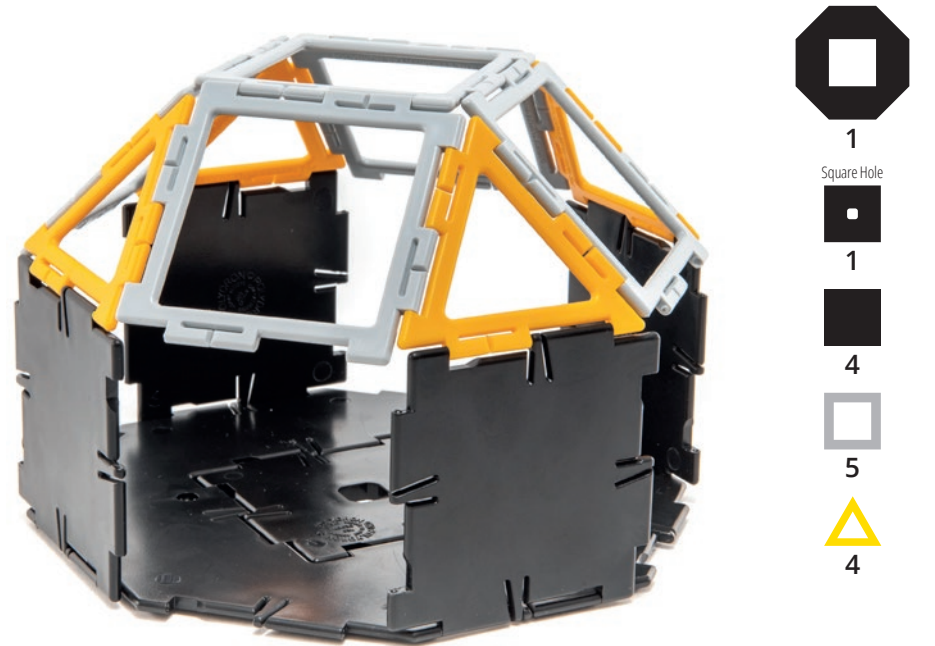

5

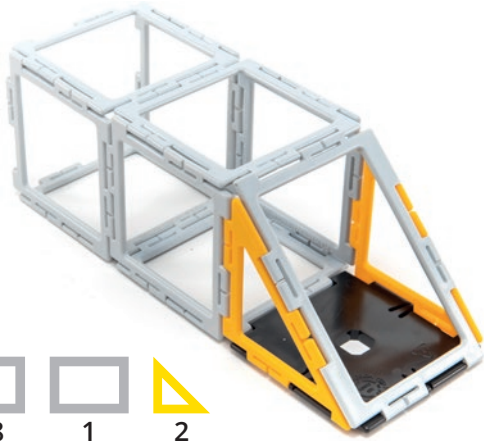

Square Hole



6



Round Hole



7 = 5 + 6



8 = 4 + 4 × 7

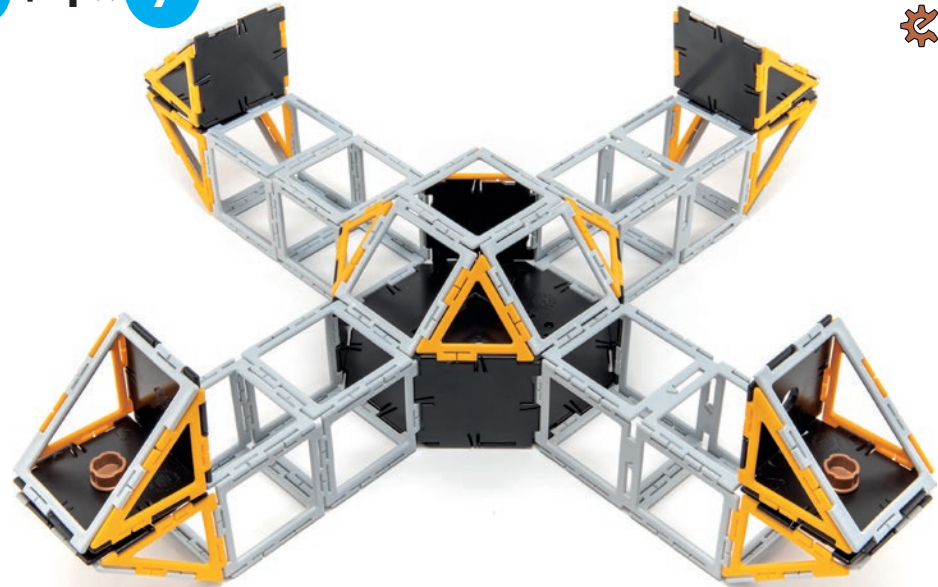

3 + 8

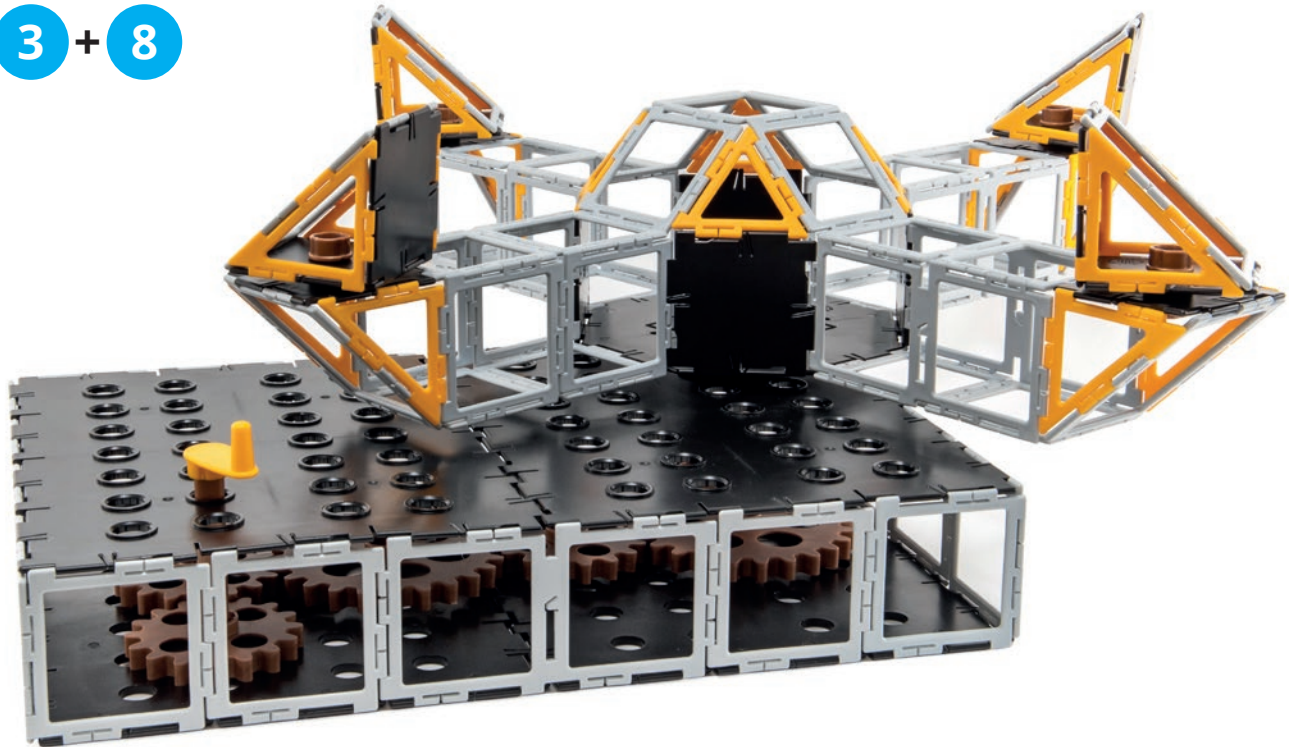



# V8 Engine





1

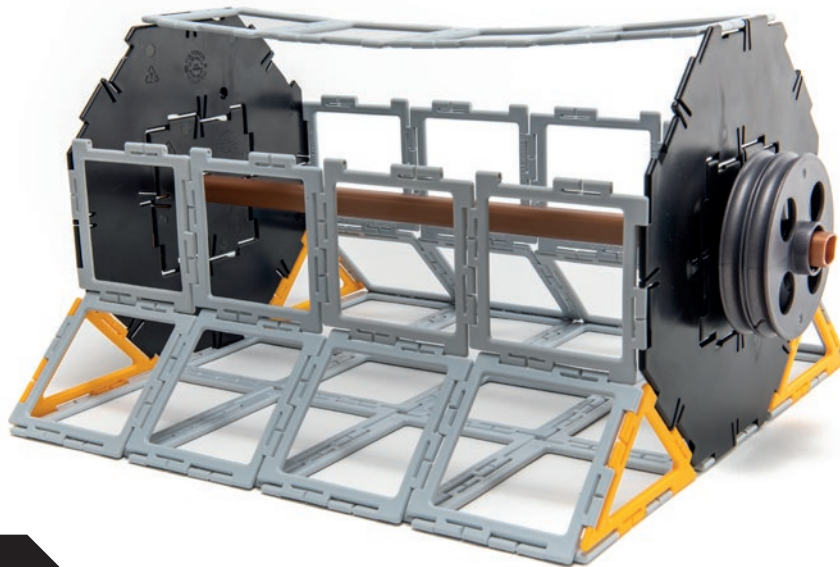
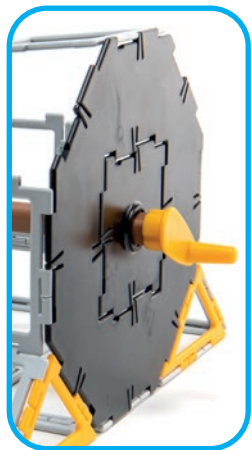

-  20
-  8
-  4

2

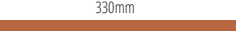

-  2
-  Round Hole 2
-  4
-  Medium Pulley 2
-  1
-  330mm 1



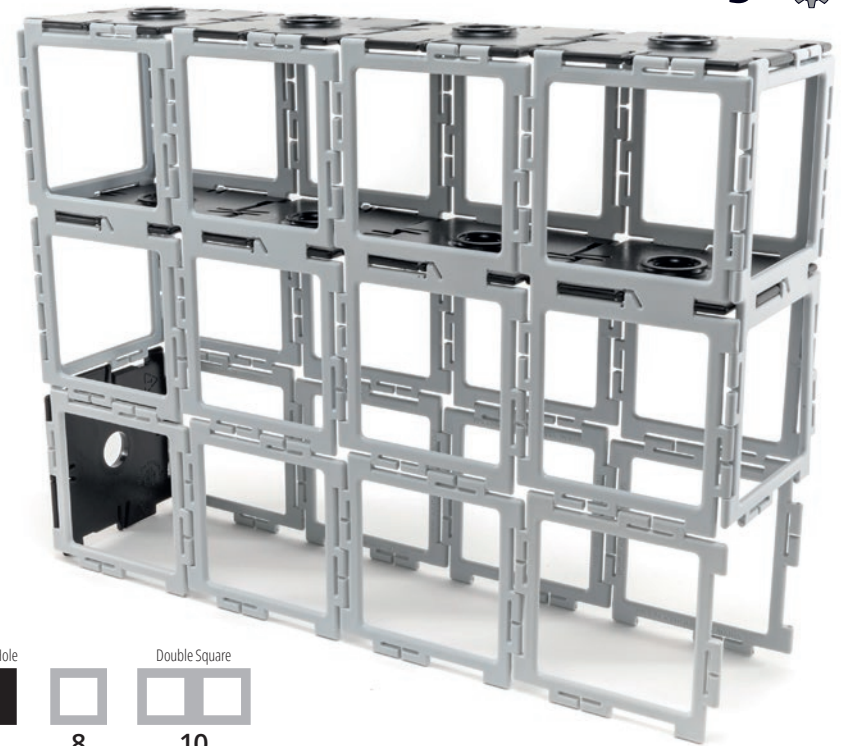

3



-  Round Hole 9
-  8
-  Double Square 10

4

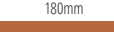
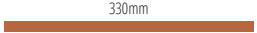

-  Small Pulley 4
-  Cam 4
-  Medium Pulley 1
-  75mm 1
-  Round Hole 1
-  180mm 4
-  330mm 1



$5 = 3 + 4$

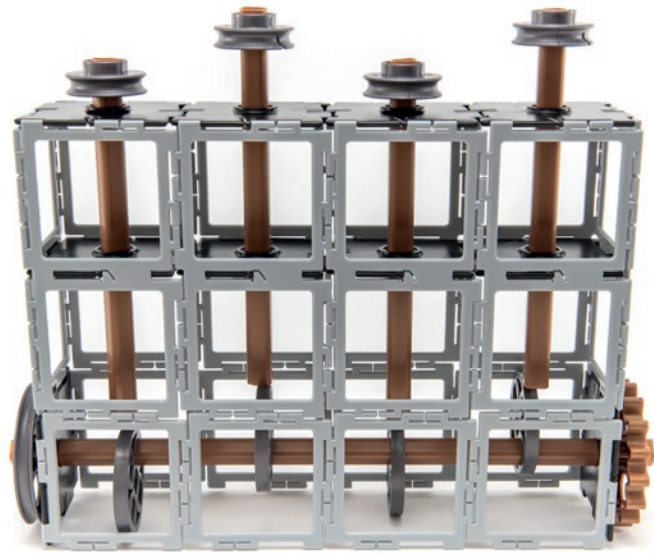

$2 + 2 \times 5$

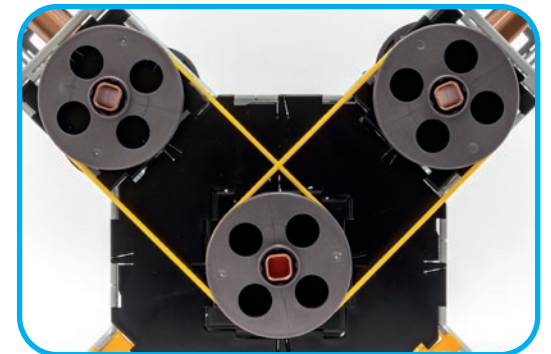
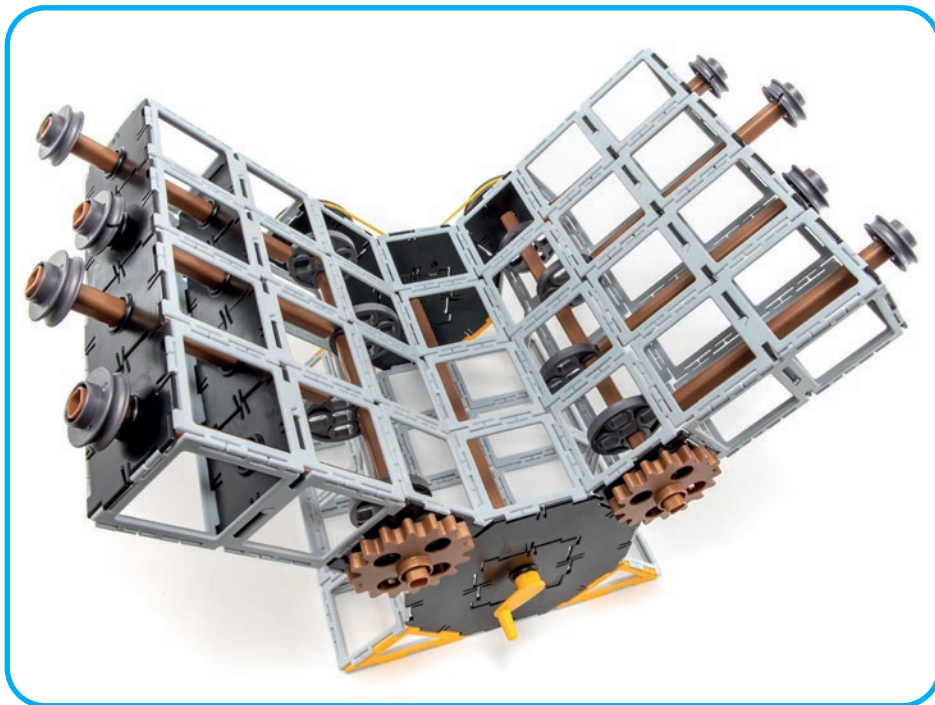
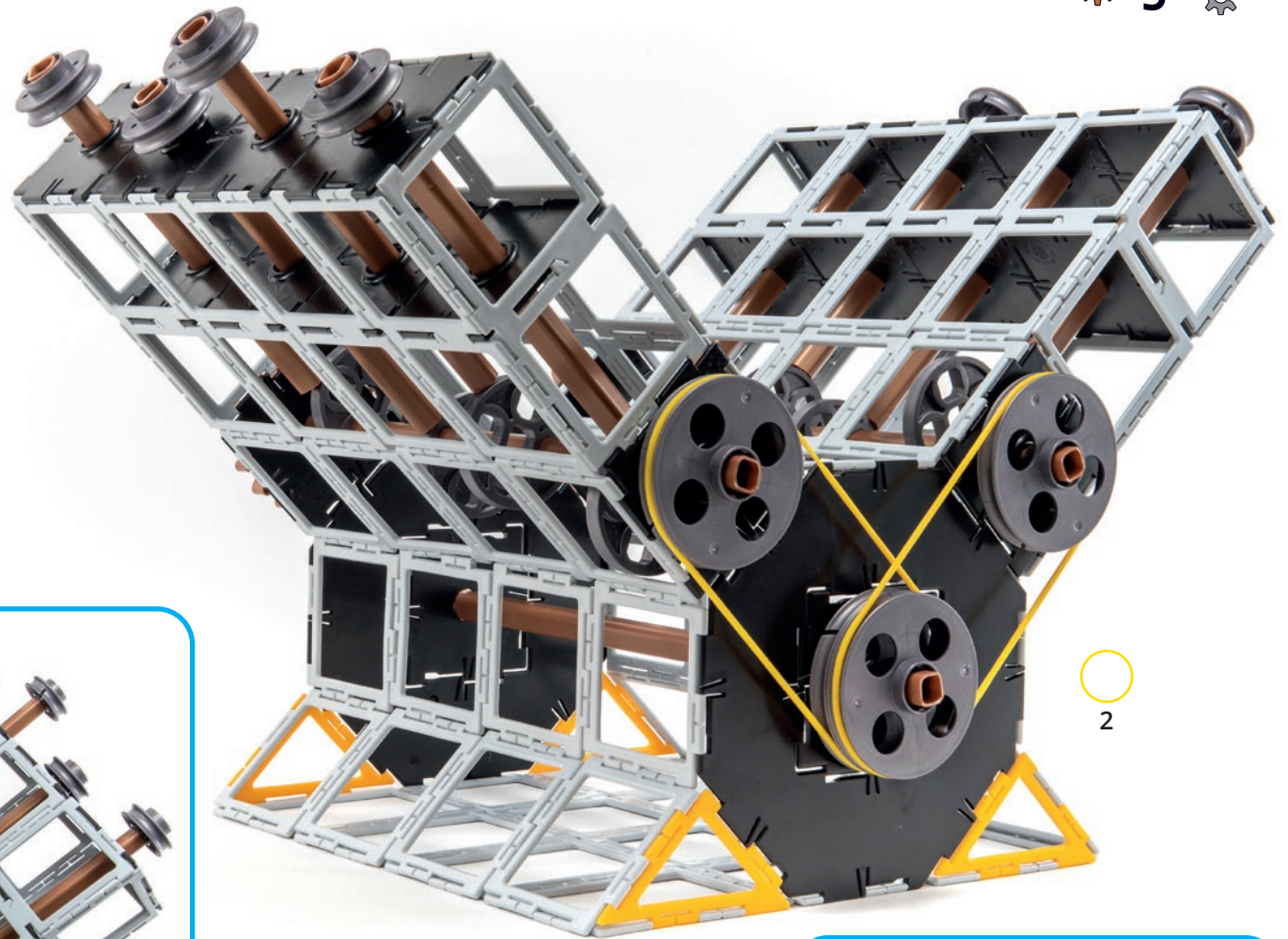



# Clock

## 1 Front Side

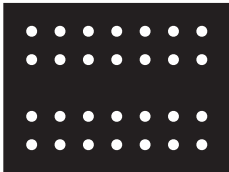

2

Double Square



6



13

90mm

2

Connector

1

## 2 Reverse Side

40mm



2

75mm



3

Connector

2

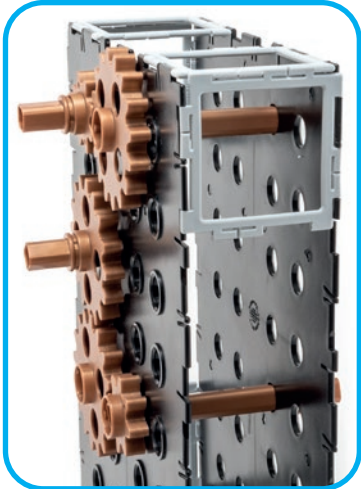

Stub Axle

3

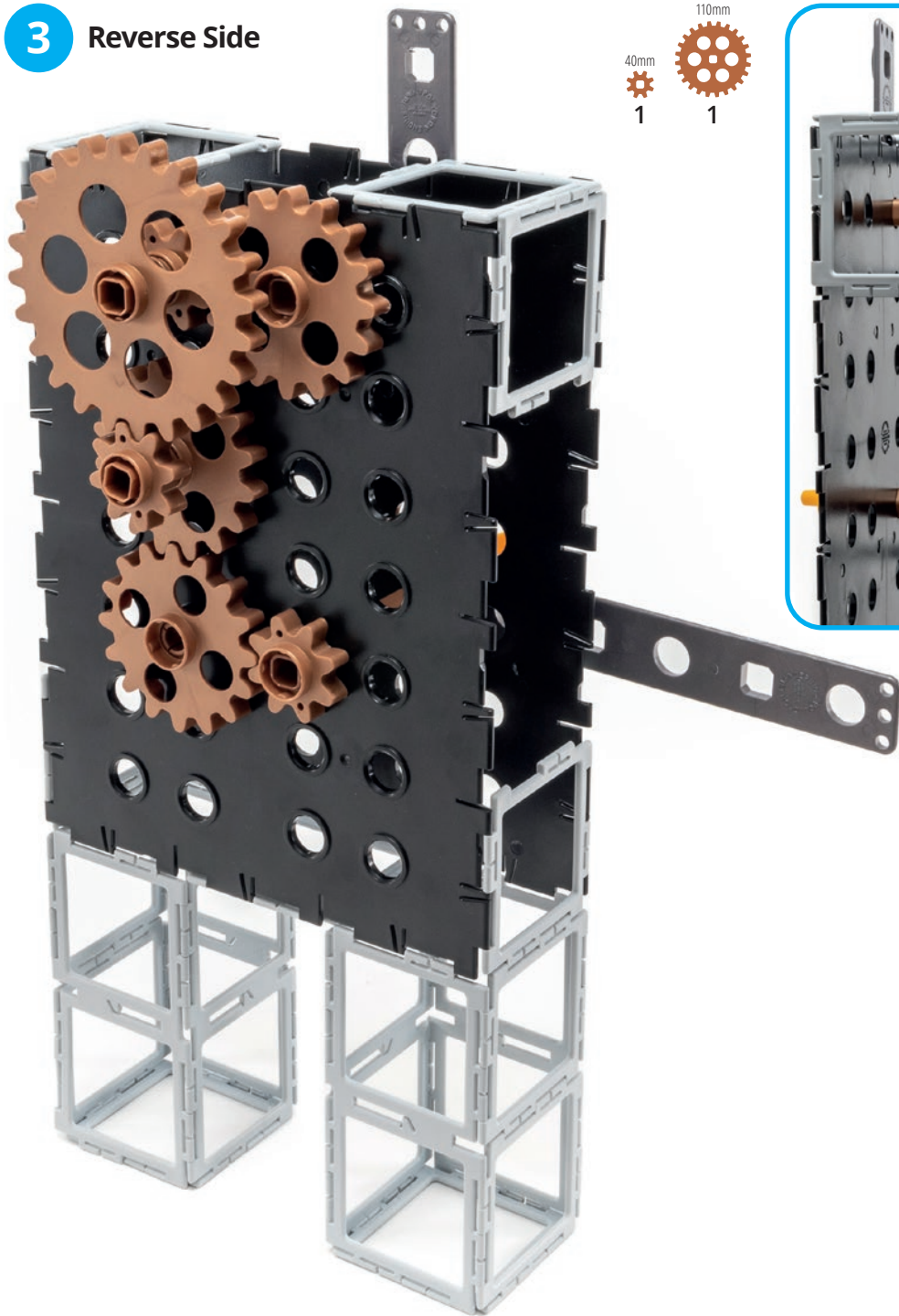

**3** Reverse Side



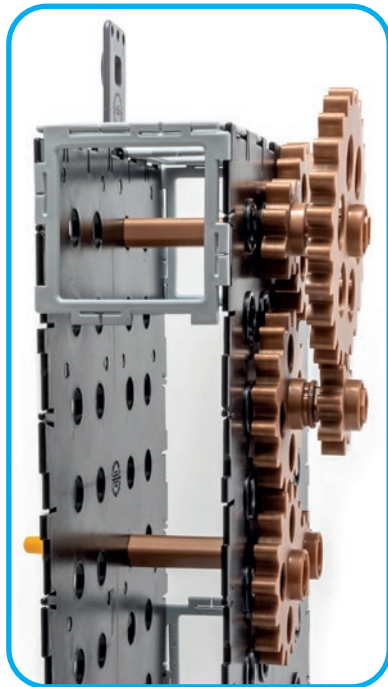

- 40mm  1
- 110mm  1

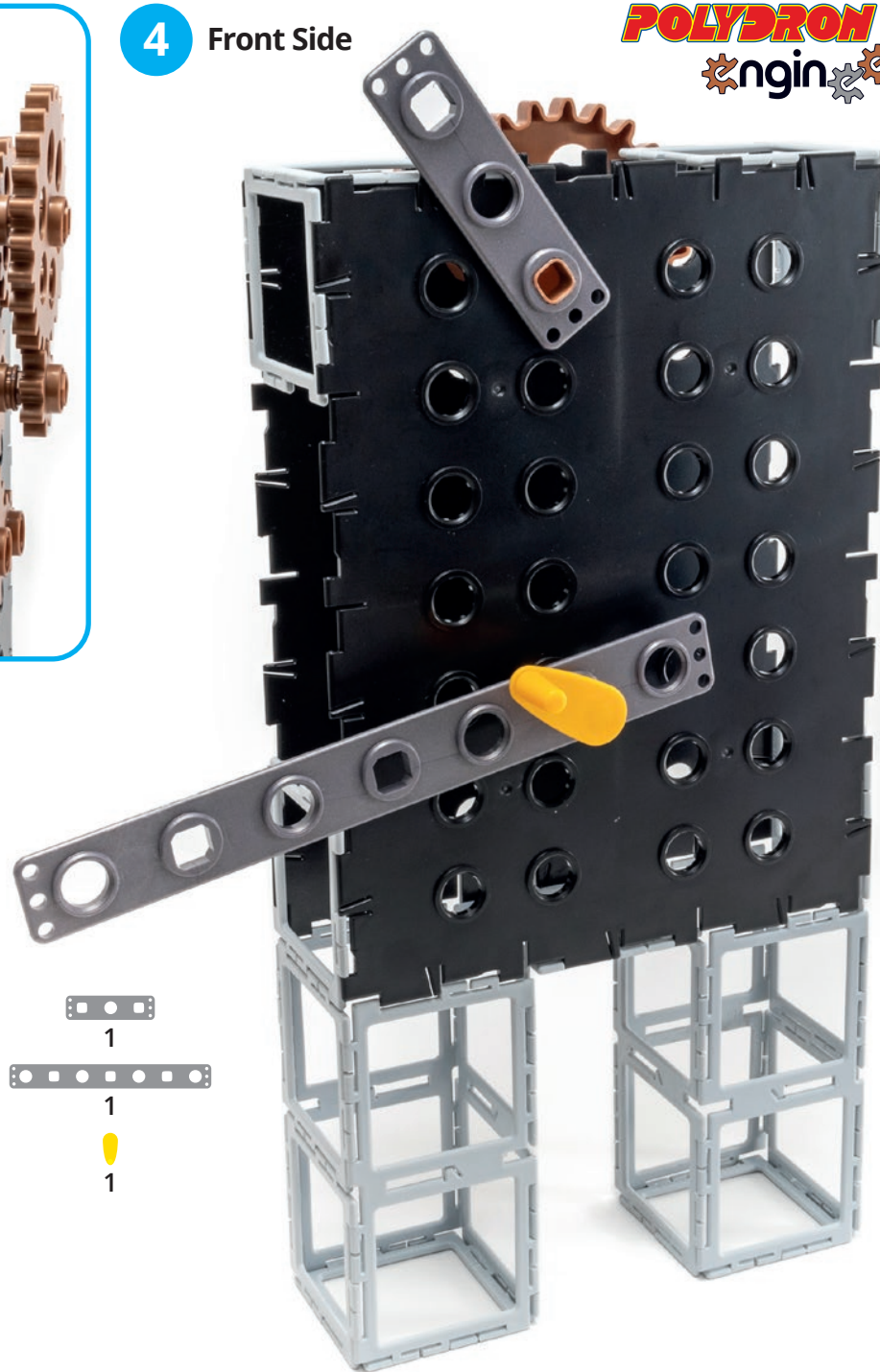

**4** Front Side



-  1
-  1
-  1



# Vertigo

1

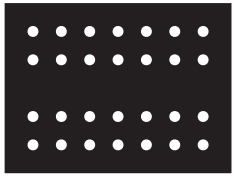

2

Round Hole



2

3

Double Square



2



2

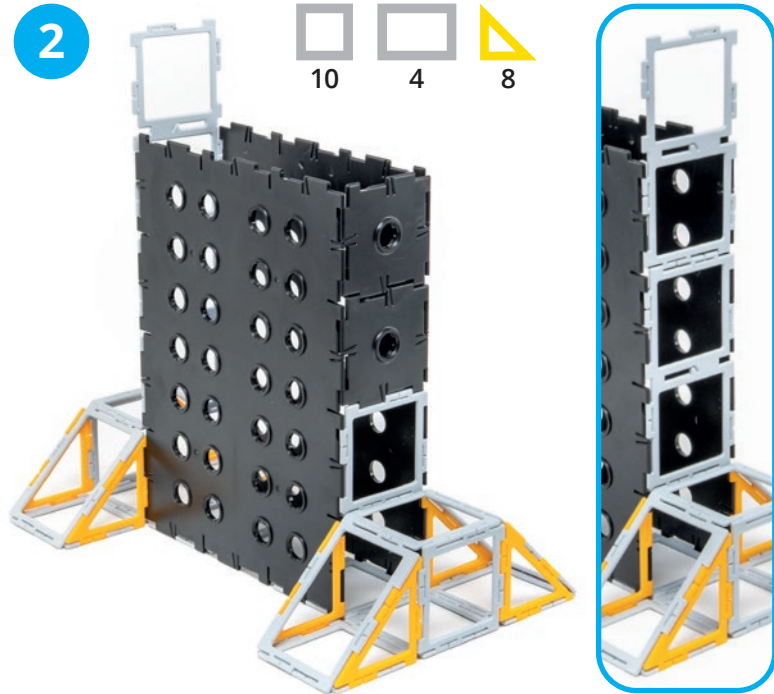

5

**POLYDRON**  
engin<sup>®</sup>

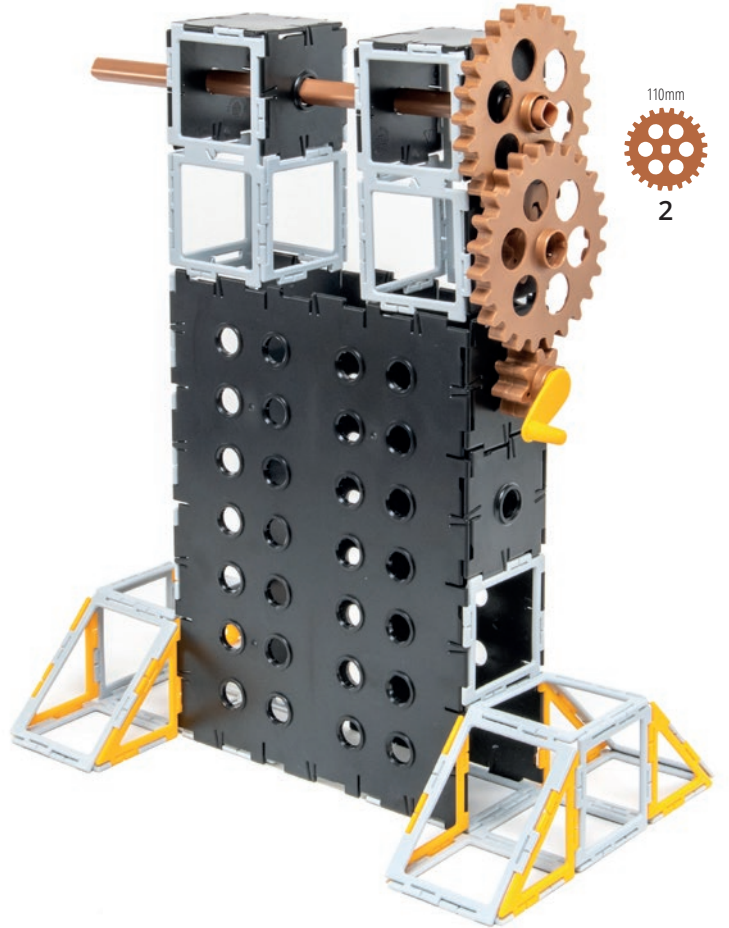

110mm

2

3

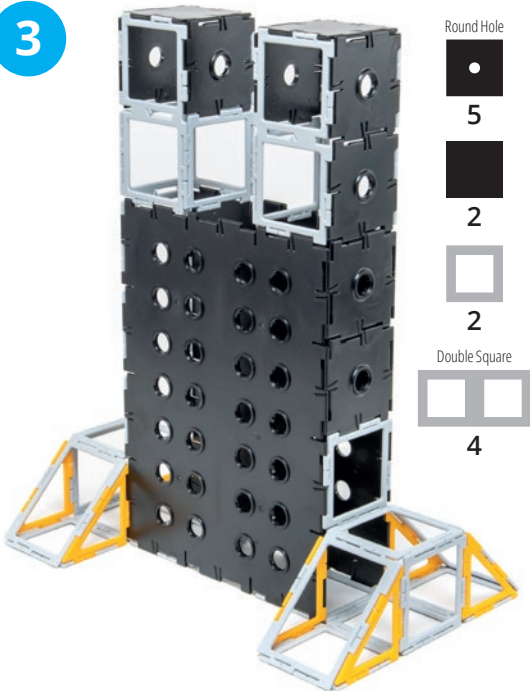

Round Hole



5



2



2

Double Square



4



4



40mm



3

1

Stub Axle



2

330mm

1

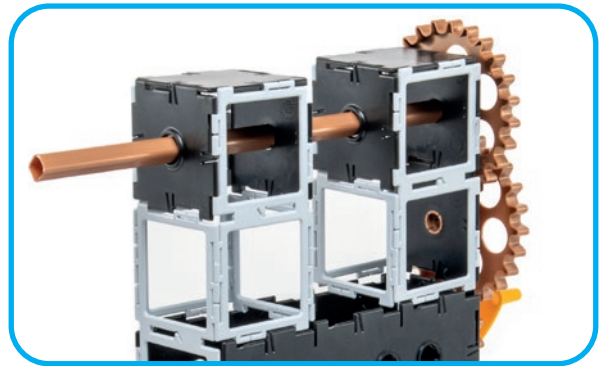



6

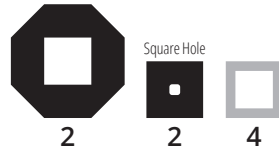

7

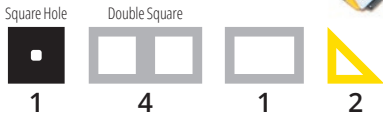
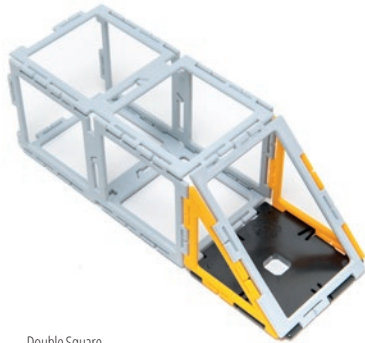

8

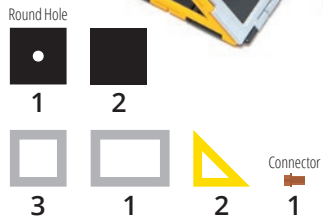
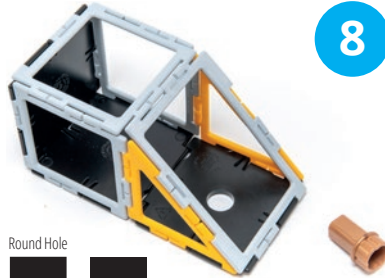

9 = 6 + 4 x 7 + 4 x 8

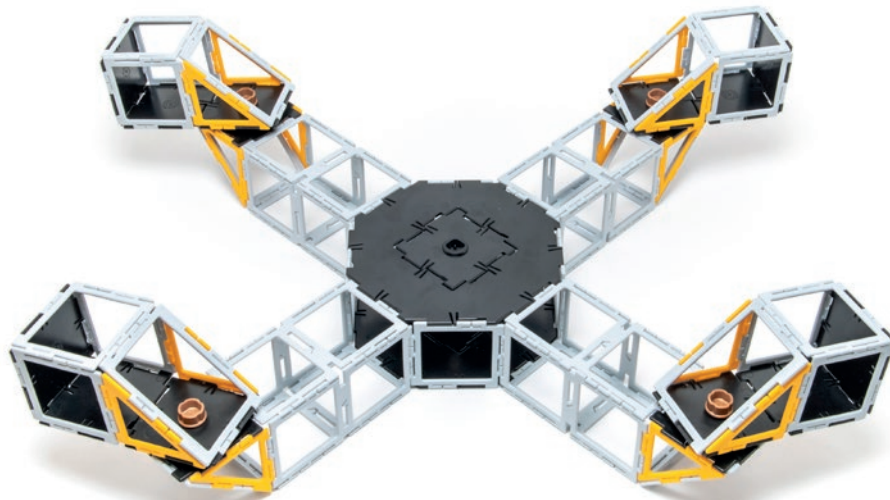

5 + 9





# Chairoplane

1

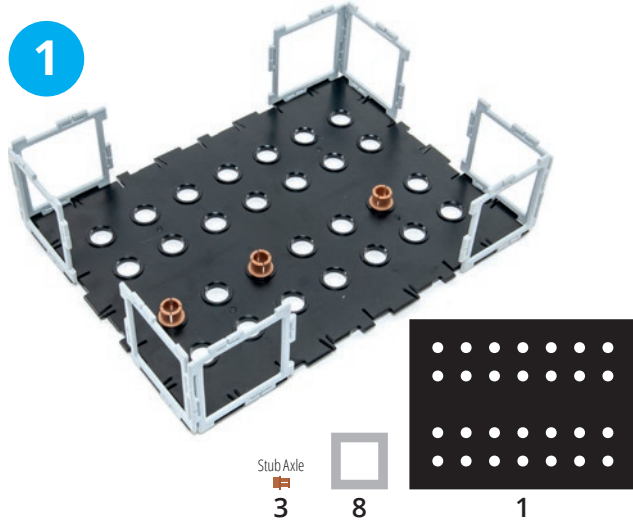

3

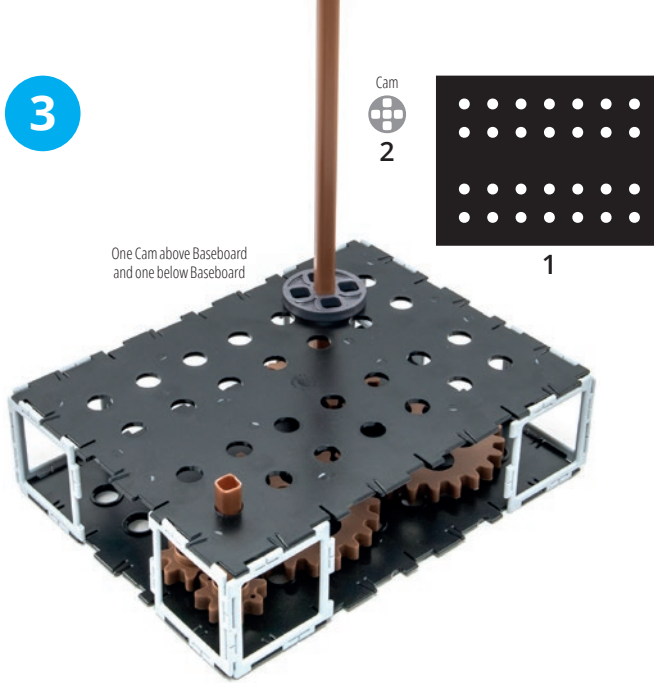

5

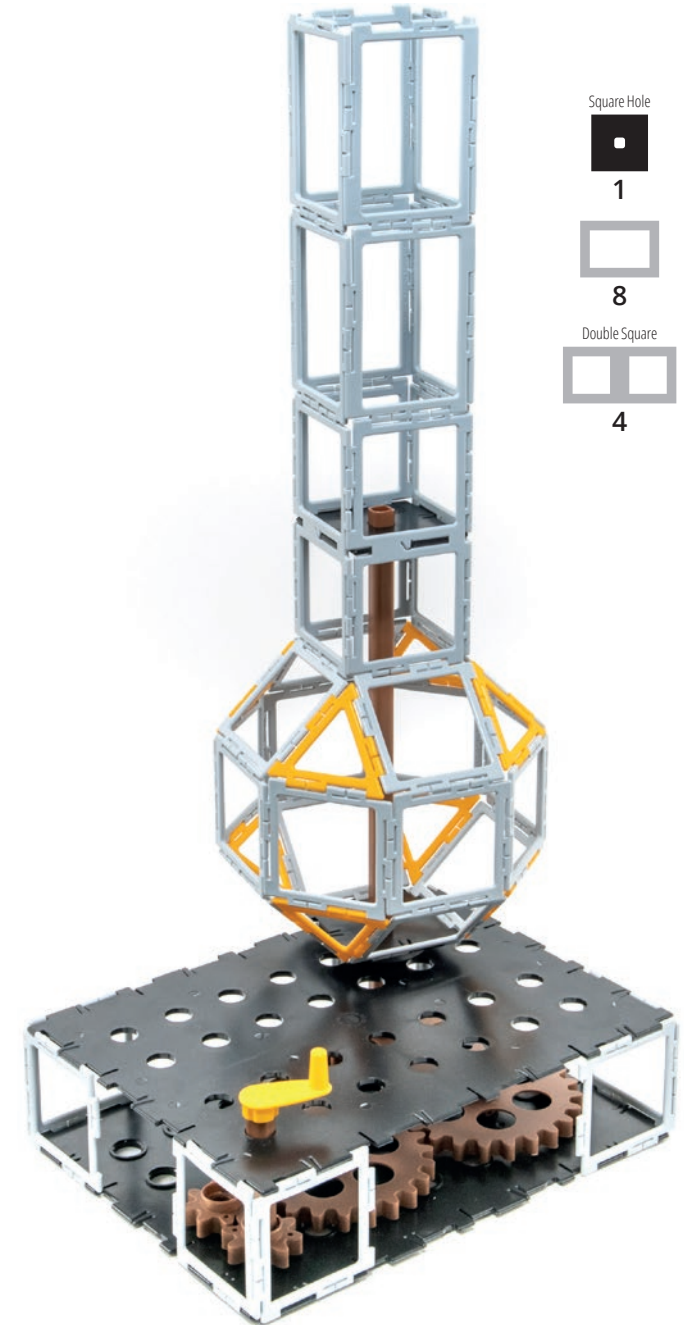

2

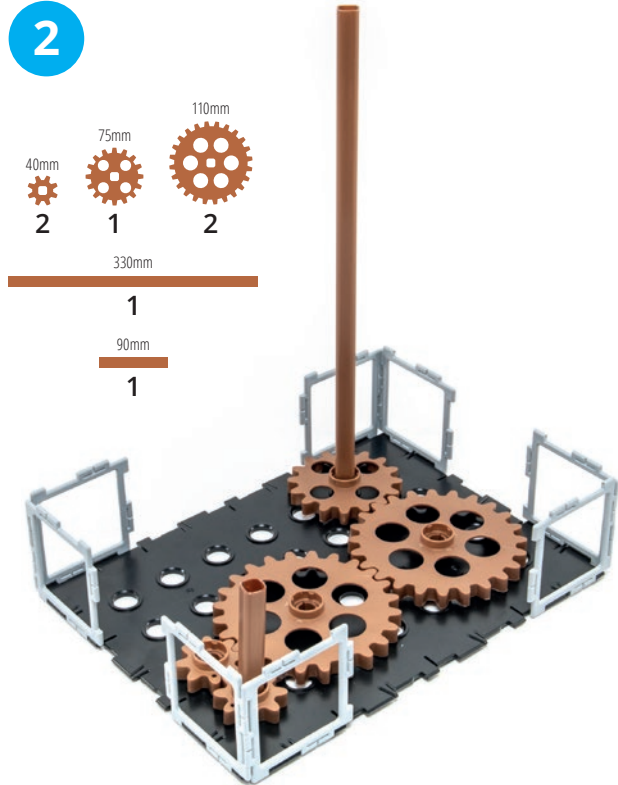

4

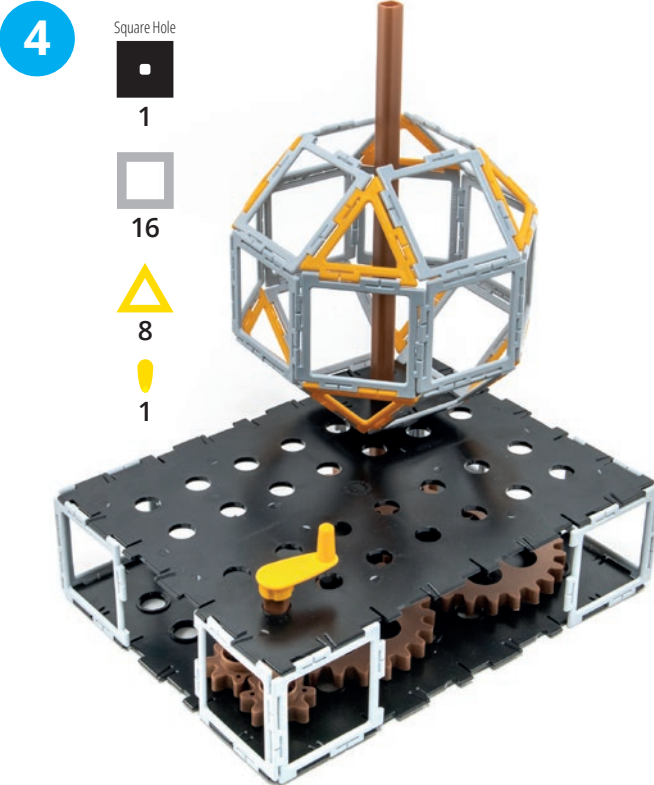

6



- Square Hole
- 1
  - 1
  - 1
  - 2
  - Connector 1



7



- Connector 1
- 1
- Square Hole 1

8 = 6 + 7

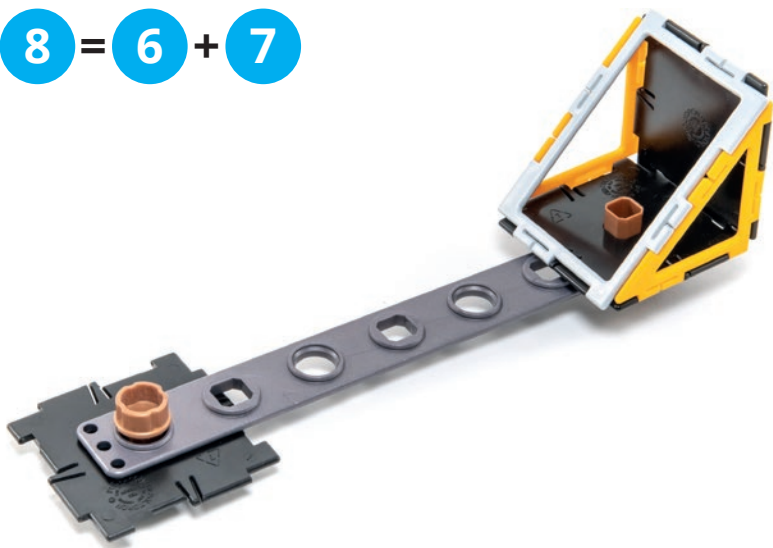

5 + 4 x 8

