

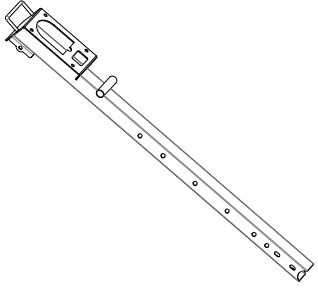

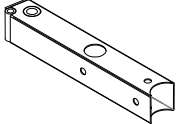

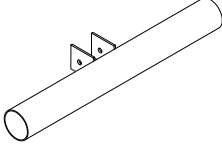

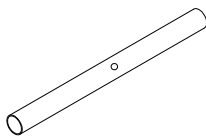



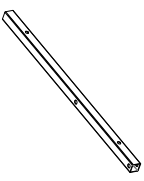
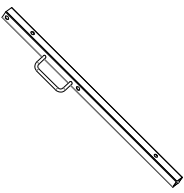

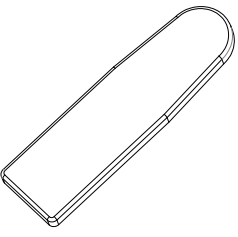
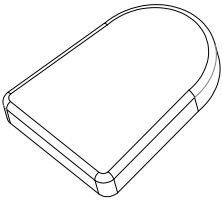

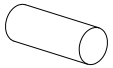

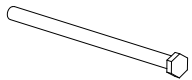
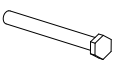
USER'S MAUNAL

PART DRAWING LIST

 <p>01# Main Frame 1pc</p>	 <p>02# Support Frame 1pc</p>	 <p>03# Base Frame 2pcs</p>
 <p>04# Foot Tube 1pc</p>	 <p>05# Carriage 1pc</p>	 <p>06# Right Backrest Frame 1pc</p>
 <p>07# Left Backrest Frame 1pc</p>	 <p>08# Backrest Support 1pc</p>	 <p>09# Backrest Cushion 1pc</p>
 <p>10# Seat Cushion 1pc</p>		

PART DRAWING LIST

 11# Knob 2pcs	 12# Small Cover 2pcs	 13# Big Cover 4pcs	 14# Carriage Sleeve 2pcs
 15# Backrest Frame Cap 4pcs	 16# M10*180mm Hex Bolt 2pcs	 17# M10*100mm Hex Bolt 1pc	 18# M10*75mm Hex Bolt 1pc
 19# M8*20mm Hex Bolt 11pcs	 20# M8*50mm Hex Bolt 4pcs	 21# M10 Washer 8pcs	 22# M8 Washer 15pcs
 23# M10 Locknut 4pcs	 24# Bushing 2pcs		

Scale 1:1

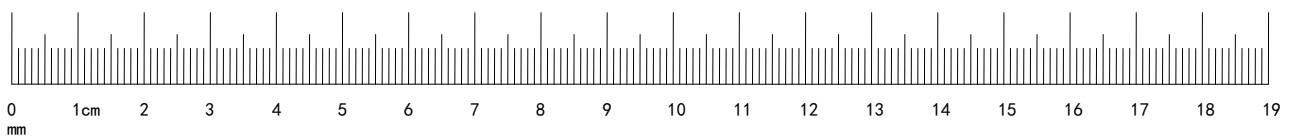
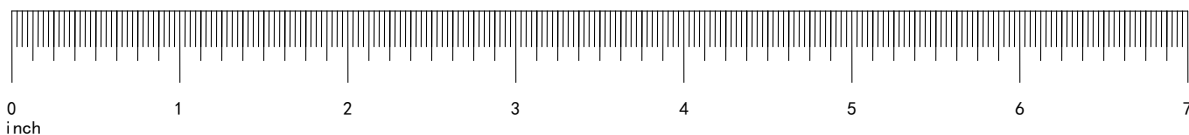

ASSEMBLY STEPS

NOTED: 1. Unpack the carton and place all parts on the floor carefully.
2. remove the packing material and check each part as manual.

STEP 1

- * Slide the Carriage (5) onto the Main Frame(1) using the Knob(11)
- * Attach the Base Frame (3) to Support Frame(2) using 3pcs M8*20mm Hex Bolt (19) and 3pcs M8 washer (22)
- * Attach the Foot Tube (4) into Support Frame(2) using 1pc M8*20mm Hex Bolt (19) and 1pc M8 washer (22)
- * Slide the Small Cover (12) onto the Foot Tube (4)

PART NO.	DESCRIPTION	Q'TY
11	Knob	1
19	M8*20mm Hex Bolt	4
22	M8 Washer	4

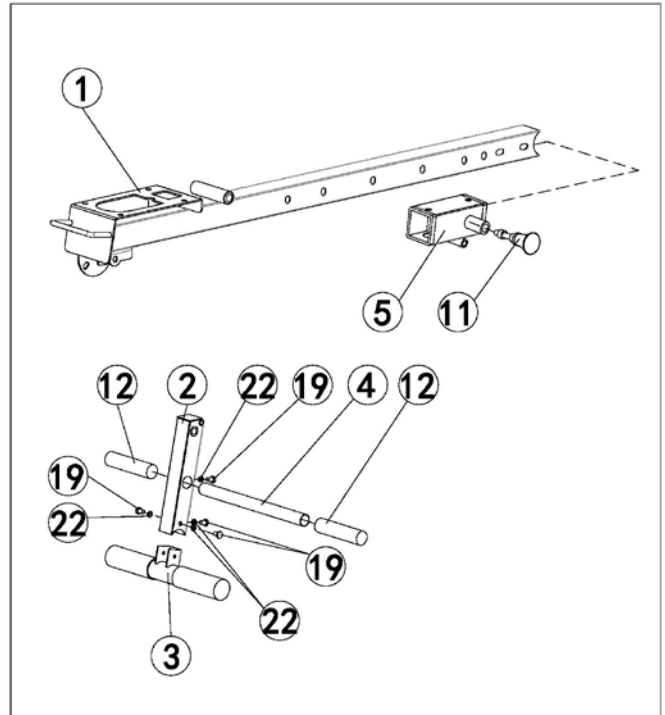

STEP 2

- * Attach another Base Frame (3) to the Main Frame (1) using 3pcs M8*20mm Hex Bolt (19) and 3pcs M8 washer (22)
- * Attach the Support Frame (2) to the Main Frame (1) using 1pc M10*75mm Hex Bolt (18) and 1pcs M10 washer (21) and 1pc M10 Locknut (23),Knob(11)

PART NO.	DESCRIPTION	Q'TY
11	Knob	1
18	M10*75mm Hex Bolt	1
19	M8*20mm Hex Bolt	3
21	M10 Washer	2
22	M8 Washer	3
23	M10 Locknut	1

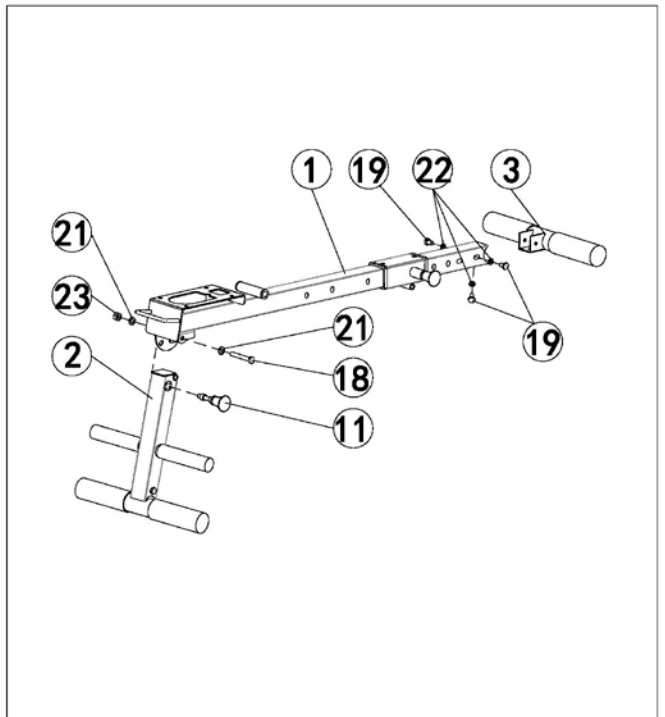

ASSEMBLY STEPS

STEP 3

- * Noted:2pcs Bushing (24) have been assembled onto the Main Frame(1)
- * Attach the Right Backrest Frame (6) and the Left Backrest Frame (7) to the Main Frame (1) using 1pc M10*180mm Hex Bolt (16) and 2pcs M10 washer (21) and 1 pc M10 Locknut(23)
- * Attach the Backrest Support (8) to the Right Backrest Frame (6) and the Left Backrest Frame (7) using 1pc M10*180mm Hex Bolt (16) and 2pcs M10 washer (21) and 1 pc M10 Locknut(23)
- * Attach the Backrest Support (8) to the Carriage (05) using 1pc M10*100mm Hex Bolt (17) and 2pcs M10 washer (21) and 1 pc M10 Locknut(23)

PART NO.	DESCRIPTION	Q' TY
16	M10*180mm Hex Bolt	2
17	M10*100mm Hex Bolt	1
21	M10 Washer	6
23	M10 Locknut	3

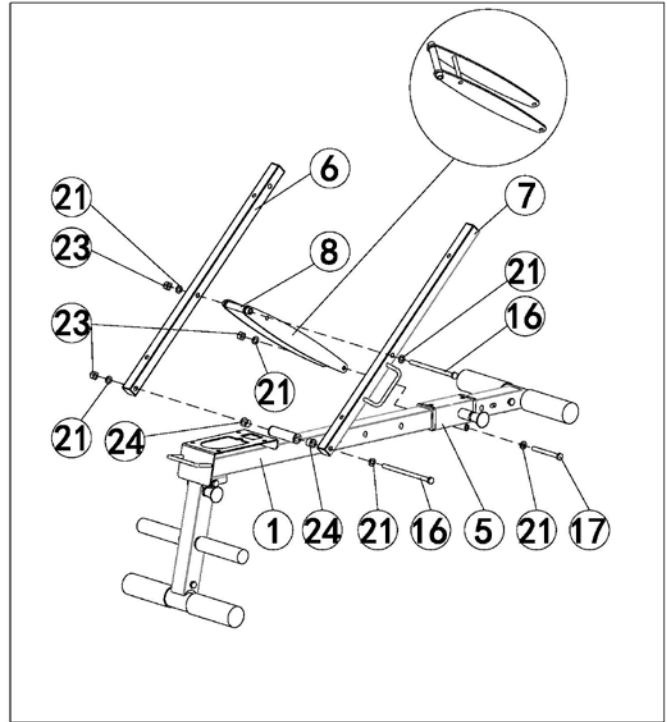

STEP 4

- * Attach the Seat Cushion (10) to the Main Frame (1) using 4pcs M8*20mm Hex Bolt (19) and 4pcs M8 washer (22)
- * Attach the Backrest Cushion (9) to Right Backrest Frame (6) and the Left Backrest Frame (7) using 4pcs M8*50mm Hex Bolt (20) and 4pcs M8 washer (22)
- * Now go back and recheck all bolts and nuts are tightened, before using machine

PART NO.	DESCRIPTION	Q' TY
19	M8*20mm Hex Bolt	4
20	M8*50mm Hex Bolt	4
22	M8 Washer	8

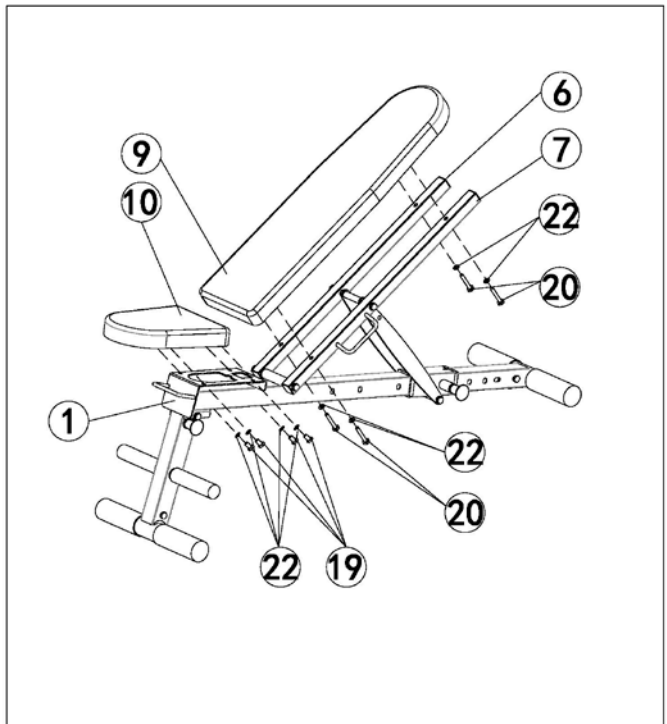

PARTS LIST

PART NO	DESCRIPTION	Q' TY
01	Main Frame	1
02	Support Frame	1
03	Base Frame	2
04	Foot Tube	1
05	Carriage	1
06	Right Backrest Frame	1
07	Left Backrest Frame	1
08	Backrest Support	1
09	Backrest Cushion	1
10	Seat Cushion	1
11	Knob	2
12	Small Cover	2
13	Big Cover	4
14	Carriage Sleeve	2
15	Backrest Frame Cap	4
16	M10*180mm Hex Bolt	2
17	M10*100mm Hex Bolt	1
18	M10*75 Bolt	1
19	M8*20mm Hex Bolt	11
20	M8*50mm Hex Bolt	4
21	M10 Washer	8
22	M8 Washer	15
23	M10 Locknut	4
24	Bushing	2

EXPLODED DRAWING

