

**0670
TODDLER DOUBLE MESSY
PLAY UNIT**



Assembly Instructions.

Please read these instructions carefully before assembling the unit and where necessary refer to the enclosed Component List.

Adults Required For Assembly.

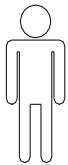

Maintenance.

Some residual dust from the manufacturing process may be apparent. This will wipe off with a damp cloth.

Your unit may be cleaned with a damp cloth.

Stubborn marks may be removed with a mild detergent or non-abrasive cream cleaner.

Examine all fasteners periodically and retighten where necessary. Care must be taken not to over tighten the fasteners.

**PLEASE WIPE ANY LIQUID OFF THE PRODUCT AS IT MAY CAUSE
DAMAGE**

An Adult Should **ALWAYS SUPERVISE PLAY!**

This unit is designed for use on a flat level surface.

Please retain our address for future reference

Manufactured by:
Mike Miller Associates Ltd.,
Syke Road, Wigton. Cumbria CA7 9NS
Tel: 016973 49774 / 45300
e: sales@twoey.co.uk
w: www.twoey.co.uk
Registered in England No: 1425839
Registered Office: The Old Brewery, Caldbeck.
Cumbria CA7 8EW

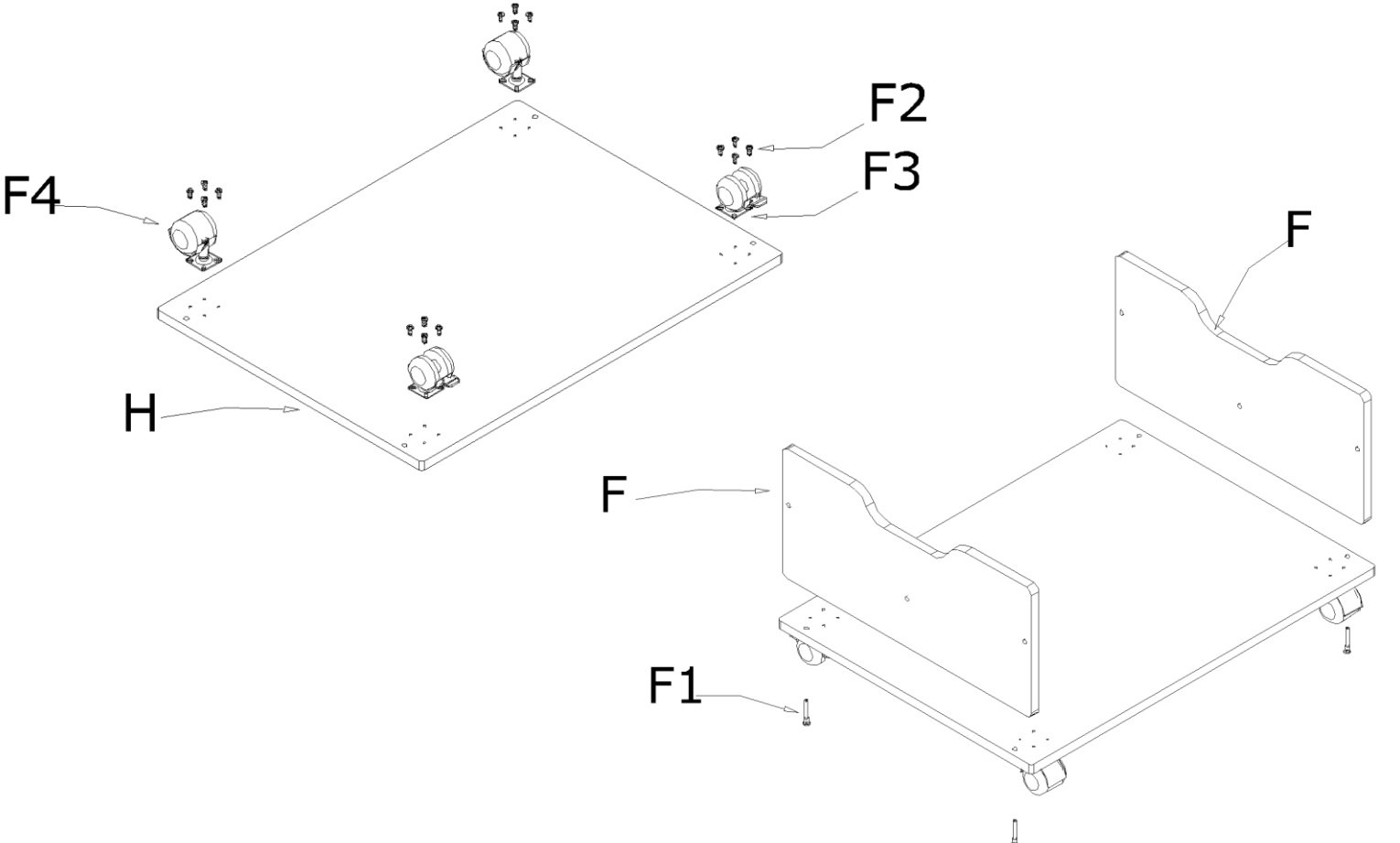
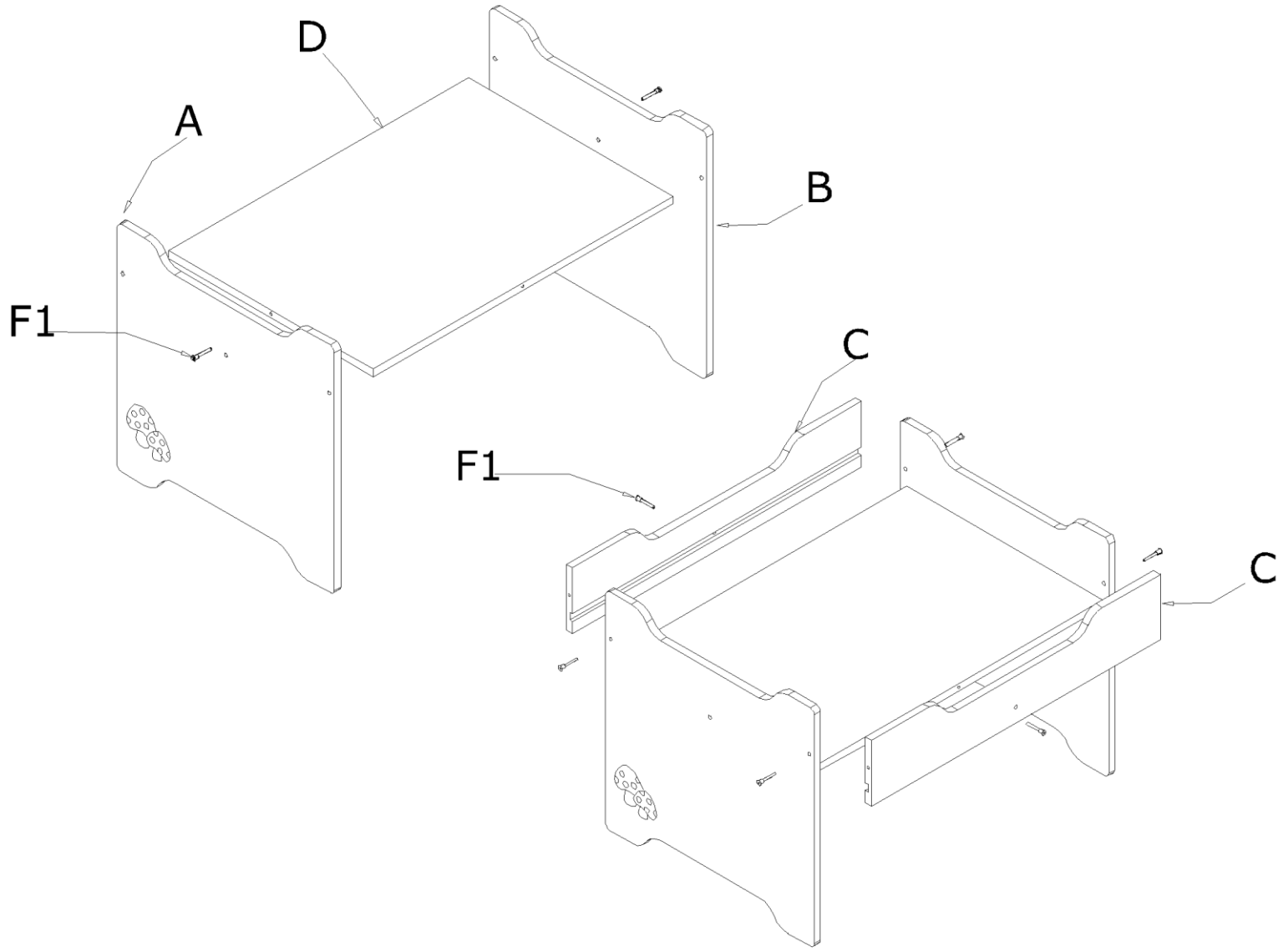

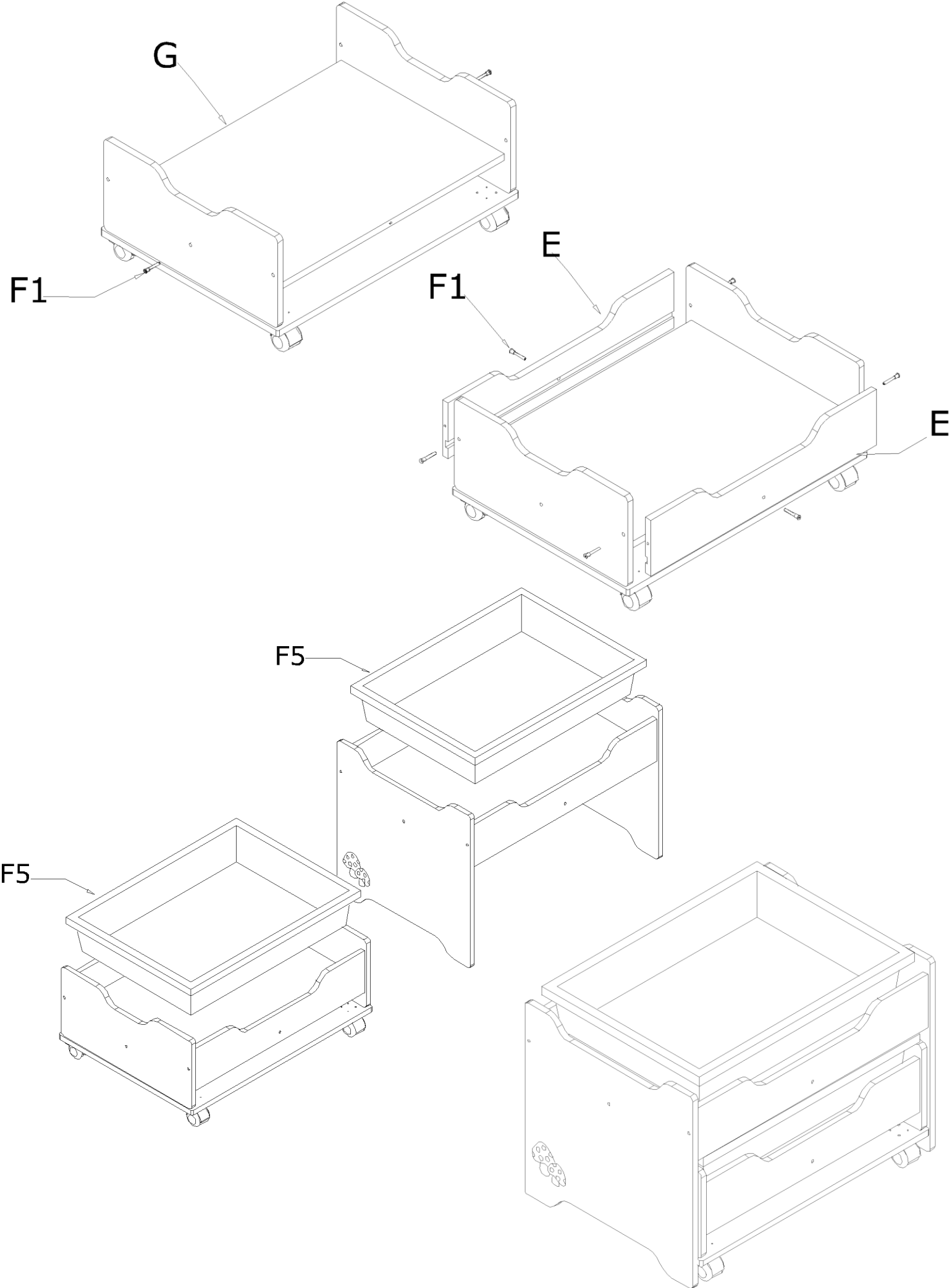

0670 - TODDLER DOUBLE MESSY PLAY UNIT (CS0849) COMPONENTS LIST

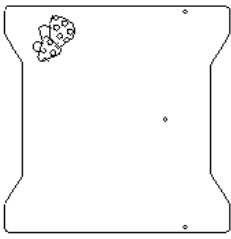

A
PN: 0660101A
QTY 1

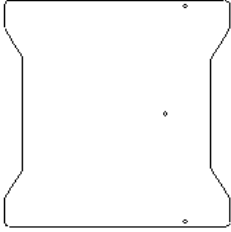

B
PN: 0660101B
QTY 1



C
PN: 0660202
QTY 2

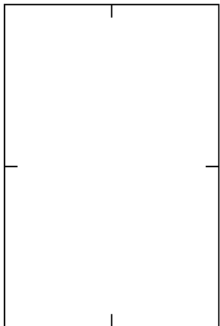

D
PN: 0660302
QTY 1

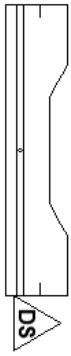

E
PN: 0670201
QTY 2



F
PN: 0670101
QTY 2

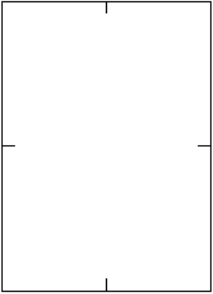

G
PN: 0670301
QTY 1

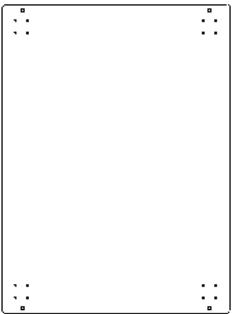



H
PN: 0670401
QTY 1



F5
PN: APTRAYCLEAR11
QTY 2

**Assembly
Instructions**

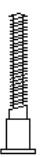
KIT LIST
(SOME EXTRA'S INCLUDED)

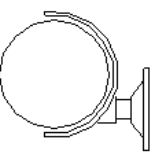
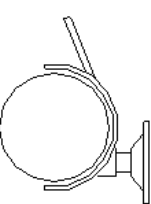
<p>F1 SUPERJOINER PN: FS6338SW4 QTY 22</p> 	<p>F2 SCREW PAN.HD. No.10 x 1/2" PN: FS101/2P QTY 18</p> 
<p>F3 CASTOR C/W PLATE PN. ACGR50P QTY 2</p> 	<p>F4 CASTOR LOCKING C/W PLATE PN. ACGR50PB QTY 2</p> 
<p>ALLEN KEY PN: AMSW4 QTY 1</p> 